



RESPONSES TO COMMENTS APPENDICES

VOLUME VI

NEWPORT BANNING RANCH PROJECT CITY OF NEWPORT BEACH

STATE CLEARINGHOUSE NO. 2009031061

Prepared for | City of Newport Beach
3300 Newport Boulevard
Newport Beach, California 92663

Prepared by | BonTerra Consulting
2 Executive Circle, Suite 175
Irvine, California 92614
T: (714) 444-9199 F: (714) 444-9599

March 16, 2012

APPENDIX A

PRELIMINARY WATER QUALITY MANAGEMENT PLAN



PRELIMINARY WATER QUALITY MANAGEMENT PLAN
(P-WQMP)

NEWPORT BANNING RANCH

Newport Beach, California

Prepared For

*NEWPORT BANNING RANCH, LLC
1300 Quail Street, Suite 100
Newport Beach, CA 92660*

Prepared By

Fuscoe Engineering, Inc.
16795 Von Karman, Suite 100
Irvine, California 92606
949.474.1960
www.fuscoe.com

Project Manager:
John Olivier, PE

Date Prepared: February 3, 2012
Job Number: 821.01.06

full circle thinking®





PRELIMINARY WATER QUALITY MANAGEMENT PLAN (P-WQMP)
NEWPORT BANNING RANCH
NEWPORT BEACH, CA

February 3, 2012

821.01.06



PRELIMINARY WATER QUALITY MANAGEMENT PLAN (P-WQMP)
NEWPORT BANNING RANCH
NEWPORT BEACH, CA

February 3, 2012

821.01.06



PRELIMINARY WATER QUALITY MANAGEMENT PLAN (P-WQMP)
NEWPORT BANNING RANCH
NEWPORT BEACH, CA

February 3, 2012

821.01.06

PRELIMINARY WATER QUALITY MANAGEMENT PLAN (P-WQMP)

NEWPORT BANNING RANCH

City of Newport Beach, County of Orange

TENTATIVE TRACT MAP NO. 17308

APN NOS. 114-170-24, 43, 49, 50, 52, 72, 75, 77, 79, 83 & 424-041-04

Prepared for:

NEWPORT BANNING RANCH, LLC
1300 Quail Street, Suite 100
Newport Beach, CA 92660

Prepared by:

FUSCOE ENGINEERING, INC.
16795 Von Karman, Suite 100
Irvine, CA 92618
949.474.1960

Date Prepared: February 3, 2012

PROJECT OWNER'S CERTIFICATION			
Permit/Application No.:	PA2008-114	Grading Permit No.:	Pending
Tract/Parcel Map and Lot(s)No.:	TTM 17308	Building Permit No.:	Pending
Address of Project Site and APN:	114-170-24, 43, 49, 50, 52, 72, 75, 77, 79, 83 & 424-041-04		

This Water Quality Management Plan (WQMP) has been prepared for NEWPORT BANNING RANCH, LLC by FUSCOE ENGINEERING, INC. The WQMP is intended to comply with the requirements of the County of Orange NPDES Stormwater Program requiring the preparation of the plan.

The undersigned, while it owns the subject property, is responsible for the implementation of the provisions of this plan , including the ongoing operation and maintenance of all best management practices (BMPs), and will ensure that this plan is amended as appropriate to reflect up-to-date conditions on the site consistent with the current Orange County Drainage Area Management Plan (DAMP) and the intent of the non-point source NPDES Permit for Waste Discharge Requirements for the County of Orange, Orange County Flood Control District and the incorporated Cities of Orange County within the Santa Ana Region. Once the undersigned transfers its interest in the property, its successors-in-interest shall bear the aforementioned responsibility to implement and amend the WQMP. An appropriate number of approved and signed copies of this document shall be available on the subject site in perpetuity.

OWNER:	
Name:	
Title:	
Company:	
Address:	
Email:	
Telephone:	
Signature:	Date:

TABLE OF CONTENTS

SECTION I	DISCRETIONARY PERMITS AND WATER QUALITY CONDITIONS	1
SECTION II	PROJECT DESCRIPTION	2
II.1	Project Description	2
II.2	Potential Storm Water Pollutants	5
II.3	Hydrologic Conditions of Concern	6
II.4	Post Development Characteristics	8
II.5	Property Ownership/Management	9
SECTION III	SITE DESCRIPTION	11
III.1	Physical Setting	11
III.2	Site Characteristics	11
III.3	Watershed Description	13
SECTION IV	BEST MANAGEMENT PRACTICES (BMPs)	14
IV.1	Project Performance Criteria	14
IV.2	Site Design and Drainage Plan	14
IV.2.1	Site Design BMPs	14
IV.2.2	Drainage Management Areas	15
IV.3	LID BMP Selection and Project Conformance Analysis	16
IV.3.1	Hydrologic Source Controls (HSCs)	17
IV.3.2	Infiltration BMPs	17
IV.3.3	Evapotranspiration, Rainwater Harvesting BMPs	18
IV.3.4	Biotreatment BMPs	24
IV.3.5	Hydromodification Control BMPs	29
IV.3.6	Regional/Sub-Regional LID BMPs	29
IV.3.7	Treatment Control BMPs	29
IV.3.8	Non-Structural Source Control BMPs	30
IV.3.9	Structural Source Control BMPs	32
IV.4	Alternative Compliance Plan	34
IV.4.1	Water Quality Credits	34
IV.4.2	Alternative Compliance Plan Information	35
SECTION V	INSPECTION/MAINTENANCE RESPONSIBILITY FOR BMPs	36
SECTION VI	SITE PLAN AND DRAINAGE PLAN	44
Exhibits		44
BMP Details		44

SECTION VII EDUCATIONAL MATERIALS 45
APPENDICES..... 46

Appendix A Supporting Calculations
Appendix B..... Notice of Transfer of Responsibility
Appendix C Educational Materials
Appendix D BMP Maintenance Supplement / O&M Plan
Appendix E..... Conditions of Approval (Placeholder – Pending Issuance)
Appendix F..... Memorandum on Limitations for Infiltration
Appendix G..... Planning-Level Water Quality Modeling

SECTION I DISCRETIONARY PERMITS AND WATER QUALITY CONDITIONS

PROJECT INFORMATION			
Permit/Application No.:	PA2008-114	Tract/Parcel Map No.:	TTM 17308
Address of Project Site and APN:	114-170-24, 43, 49, 50, 52, 72, 75, 77, 79, 83 & 424-041-04		
WATER QUALITY CONDITIONS			
Water Quality Conditions:	Pending. To be provided in the Final WQMP.		
WATERSHED-BASED PLAN CONDITIONS			
Applicable conditions from watershed - based plans including WIHMPs and TMDLS:	Not Applicable.		

SECTION II PROJECT DESCRIPTION

II.1 PROJECT DESCRIPTION

The purpose of this P-WQMP is to fulfill the requirements of the 2011 Model WQMP which requires preparation of a P-WQMP at the CEQA level of entitlement. The majority of the information provided has been previously summarized and reported in Section 4.4 Hydrology and Water Quality and Appendix C of the draft environmental impact report (DEIR) (Hydrology and Water Quality Appendix). In some instances, additional assessments and calculations consistent with the 2011 Model WQMP and Project Description have been provided that supports the original feasibility assessments and conclusions provided in Section 4.4 and Appendix C of the DEIR. In other instances, additional details are provided to further clarify water quality measures previously discussed within the Project Description, Section 4.4 and Appendix C.

The Newport Banning Ranch property encompasses approximately 401.1 acres within unincorporated County of Orange (City of Newport Beach sphere of influence) and portions of the City of Newport Beach, California. The property is bounded on the south by the West Coast Highway (WCH), to the west by the Santa Ana River channel, and by existing residential and commercial developments to the north and east (see Vicinity Map in Section VI). The entire property is situated within the Coastal Zone Jurisdictional Boundary as established by the California Coastal Act, and is therefore also subject to the planning and regulatory jurisdiction of the California Coastal Commission. The southwestern border of the property is less than one half mile from the Pacific Ocean and adjoining beaches. The City of Costa Mesa, including Talbert Regional Park, is adjacent to the northern and a portion of the eastern project boundaries. Wetland areas restored by the US Army Corp of Engineers (USACOE) extend up the Site's western boundary and separate the site from the Santa Ana River channel. The City of Huntington Beach is located west of the Santa Ana River, adjacent to the Site's western boundary.

For more than 50 years, the site has been used as an operating oil field and today, remnants of old wells and pipelines coexist with currently operating pump and processing facilities. Most of the active oil facilities are located in the central portion of the Upland Mesa and adjoining Lowland Area of the property. Currently, there are over 460 producing, potentially producing, and abandoned wells along with related roads, pipelines, and associated facilities located throughout the Newport Banning Ranch property.

The proposed Newport Banning Ranch Project includes the development of roughly 149 acres of the larger 401-acre project site for residential, commercial, and recreational land uses. Over fifty percent of the property will be retained as open space, with restored wetland and habitat areas located throughout the Lowland and Upland Mesa areas. Below is a summary of the proposed development:

- **Residential Areas:** Approximately 76 acres (or 16%) of the project site will be devoted to Residential Land Use. This type of land use is divided into the following districts:
 - Low Density Residential (LDR) District: Approximately 13 acres of LDR use development is planned that may include custom homes or larger individual lots.

- Low-Medium Density Residential (LMDR) District: Approximately 21 acres of LMDR land use is planned that may include single-family detached homes, single-family attached homes as well as multi-family housing.
- Medium Density Residential (MDR) District: Approximately 42 acres of MDR land use is planned that may include single-family detached homes, single-family attached homes and multi-family residential projects. This land use will also include smaller convenience commercial sales sites and service sites to encourage pedestrian and bicycle use.
- Mixed Use/Residential (MU/R) District: Approximately 21 acres of MU/R land use is planned along the eastern side of North Bluff Road. It adjoins Costa Mesa's "MesaWest Bluffs Urban Plan Area" (proposed mixed-use redevelopment) to the east, which currently is made up of light industrial developments and mobile home parks. Consistent with Costa Mesa's MesaWest Bluffs Urban Plan, this will be the most-urban environment within the Newport Banning Ranch site. The MU/R District will allow 3-, 4-, and 5-story attached residential neighborhoods with innovative architecture, creative parking solutions, and on-site recreation centers with the potential for lofts, live-work units, and/or commercial development as part of a vertically and/or horizontally integrated mixed use development. It is anticipated that this higher density residential area could also accommodate affordable housing units as defined by the City of Newport Beach and described in an Affordable Housing Implementation Plan (AHIP) prepared for the Project, and potentially in the future Pre-Annexation Development Agreement (PADA) between the Landowner/Master Developer and the City.
- **Visitor-Serving Resort:** The Visitor-Serving Resort Overlay District will provide a maximum of 75 overnight accommodations in an "inn" type setting integrated within the base Residential District. The design will include an iconic architectural element for the community and permit a spa and wellness center, restaurant(s), and limited visitor-serving commercial facilities as part of the resort. The residential units permitted in the base district will be conventionally owned but have opportunities to use the spa and wellness center, restaurants, and/or other facilities and amenities provided by the resort.
- **Parks and Recreational Areas:** Both active and passive public parks will be located throughout the project site. Multiple trails will be located throughout the site and adjacent areas to connect to the regional recreational facilities. In addition, smaller greenways and neighborhood focal points will be placed within the residential areas.
- **Open Space Areas:** various open space uses are proposed throughout the Lowland, Upland, Bluff, and Arroyo areas, including trails, habitat, wetlands, and arroyos.
- **Green Streets:** Many of the larger streets and arterials throughout the project site will be designed with "green street" and other low impact development (LID) features. Green streets are carefully designed roadways that incorporate sustainable design elements that may include narrower pavement widths, canopy street trees, traffic calming features, and alternative street lighting systems. In addition, landscaping along the street edges and within setback areas provide additional opportunities for treatment of storm water runoff from the streets and adjacent development areas.
- **Oil Consolidation Sites:** Since on-site oil operations are expected to continue, the Project will include a phased abandonment and consolidation of facilities to specific areas of the site to continue operations after development. Well abandonment and remediation processes will be conducted in accordance with all relevant Federal, State, and local laws and regulations.

DESCRIPTION OF PROPOSED PROJECT				
WQMP Development Category:	1. New development projects that create 10,000 square feet or more of impervious surface. This category includes commercial, industrial, residential housing subdivisions, mixed-use, and public projects on private or public property that falls under the planning and building authority or the Permittees.			
Project Area:	401.1 gross acres 235.8 acres open space / 165.3 acres of development including 51.4 acres of public parks/recreation			
# of Dwelling Units:	1,375			
SIC Code:	Pending – to be provided in Final WQMP.			
Narrative Project Description:	See above.			
Project Features	<p>An appropriate number of trash enclosures will be located within the higher-density development areas of the project site (e.g., apartments). Specific number and locations of the trash enclosures will be documented in the Final WQMP. Trash enclosures will be covered and walled on 3 sides to preclude rainfall and runoff (gate comprising the fourth side). Any restaurants/food preparation areas included as part of the Visitor Serving Resort land uses will be handled indoors, and the eating area tables will be covered with a canopy and designed to preclude precipitation and runoff. Grease interceptors will be located in the sanitary sewer systems where applicable.</p> <p>No loading docks, outdoor material storage areas, wash areas or fueling areas are proposed as part of the project. In the event site features are added to the proposed Project that are not identified in this WQMP, these features will be designed in accordance with the Orange County Drainage Area Management Plan (OC DAMP) Model WQMP requirements and City LIP and verified during the precise grade plan check review process.</p>			
Project Area:	Pervious Area (ac or ft²)	Pervious Area Percentage	Impervious Area (ac or ft²)	Impervious Area Percentage
Pre-Project Conditions¹:	355 ac	77%	46 ac	11%
Post-Project Conditions:	301 ac	75%	100 ac	25%

¹ Approximately 185 acres of the 401 acre site are currently used for oil field operations including oil wells, infrastructure, trailers, compacted dirt roads, storage facilities and paved parking areas. A conservative 25% impervious amount has been assumed.

DESCRIPTION OF PROPOSED PROJECT	
Drainage Patterns/Connections:	<p>In general, the Project’s natural drainage flows from the higher elevations in the east toward lower elevations to the west. Off-site drainage from the existing urban areas of the cities of Costa Mesa and Newport Beach enter the project site through storm drain culverts at the upstream ends of the Arroyos. Within the project boundary, the Northern and Southern Arroyos and Semeniuk Slough convey runoff towards the Salt Marsh Basin and Lowland Area. There are no major existing storm drain facilities within the project boundary. In the southern-most portion of the site, an existing Caltrans-owned underground reinforced concrete box (RCB) storm drain along West Coast Highway (WCH) also collects runoff from the site, discharging to the Semeniuk Slough channel.</p> <p>There are several tidal gates and control pipes that regulate tidal flows between the Santa Ana River and the Semeniuk Slough and Lowland Area of the project site. The default position of the gates is open to allow tidal flows to circulate through the Marsh basin. The water surface elevation of the Santa Ana River controls the gates and determines whether local storm water runoff can be discharged into the river. Refer to Section II.4 for a description of the proposed drainage facilities.</p>

II.2 POTENTIAL STORM WATER POLLUTANTS

The table below, derived from Table 2 of the Countywide Model WQMP Technical Guidance Document (May 2011), summarizes the categories of land use or project features of concern and the general pollutant categories associated with them.

ANTICIPATED & POTENTIAL POLLUTANTS GENERATED BY LAND USE TYPE								
Priority Project Categories and/or Project Features	General Pollutant Categories							
	Suspended Solid/ Sediments	Nutrients	Heavy Metals	Pathogens (Bacteria/ Virus)	Pesticides	Oil & Grease	Toxic Organic Compounds	Trash & Debris
Detached Residential Development	E	E	N	E	E	E	N	E
Attached Residential Development	E	E	N	E	E	E ⁽²⁾	N	E
Commercial/Industrial Development	E ⁽¹⁾	E ⁽¹⁾	E ⁽⁵⁾	E ⁽³⁾	E ⁽¹⁾	E	E	E
Restaurants	E ⁽¹⁾⁽²⁾	E ⁽¹⁾	E ⁽²⁾	E	E ⁽¹⁾	E	N	E
Parking Lots	E	E ⁽¹⁾	E	E ⁽⁴⁾	E ⁽¹⁾	E	E	E
Streets, Highways, & Freeways	E	E ⁽¹⁾	E	E ⁽⁴⁾	E ⁽¹⁾	E	E	E

ANTICIPATED & POTENTIAL POLLUTANTS GENERATED BY LAND USE TYPE								
Priority Project Categories and/or Project Features	General Pollutant Categories							
	Suspended Solid/Sediments	Nutrients	Heavy Metals	Pathogens (Bacteria/Virus)	Pesticides	Oil & Grease	Toxic Organic Compounds	Trash & Debris
Notes: E = expected to be of concern N = not expected to be of concern (1) Expected pollutant if landscaping exists on-site, otherwise not expected. (2) Expected pollutant if the project includes uncovered parking areas, otherwise not expected. (3) Expected pollutant if land use involves food or animal waste products, otherwise not expected. (4) Bacterial indicators are routinely detected in pavement runoff. (5) Expected if outdoor storage or metal roofs, otherwise not expected. Source: County of Orange. (2011, May 19). Technical Guidance Document for the Preparation of Conceptual/ Preliminary and/or Project Water Quality Management Plans (WQMPs). Table 2.1.								

POLLUTANTS OF CONCERN		
Pollutant	E = Expected to be of concern N = Not Expected to be of concern	Additional Information and Comments
Suspended Solid/Sediment	E	
Nutrients	E	
Heavy Metals	E	
Pathogens (Bacteria/Virus)	E	303(d) Impairment (Newport Slough)
Pesticides	E	
Oil & Grease	E	
Toxic Organic Compounds	E	
Trash & Debris	E	

II.3 HYDROLOGIC CONDITIONS OF CONCERN

The purpose of this section is to identify any hydrologic conditions of concern (HCOC) with respect to downstream flooding, erosion potential of natural channels downstream, impacts of increased flows on natural habitat, etc. As specified in Section 2.3.3 of the 2011 Model WQMP, projects must identify and mitigate any HCOCs. A HCOC is a combination of upland hydrologic conditions and stream biological and physical conditions that presents a condition of concern for physical and/or biological degradation of streams or natural drainage channels.

In the North Orange County permit area, HCOCs are considered to exist if any streams located downstream from the project are determined to be potentially susceptible to hydromodification impacts and either of the following conditions exists:

- Post-development runoff volume for the 2-yr, 24-hr storm exceeds the pre-development runoff volume for the 2-yr, 24-hr storm by more than 5 percent

or

- Time of concentration (T_c) of post-development runoff for the 2-yr, 24-hr storm event exceeds the time of concentration of the pre-development condition for the 2-yr, 24-hr storm event by more than 5 percent.

If these conditions do not exist or streams are not potentially susceptible to hydromodification impacts, an HCOC does not exist and hydromodification does not need to be considered further. In the North Orange County permit area, downstream channels are considered not susceptible to hydromodification, and therefore do not have the potential for a HCOC, if all downstream conveyance channels that will receive runoff from the project are engineered, hardened, and regularly maintained to ensure design flow capacity, or drain into a tidally influenced water body and no sensitive habitat areas will be affected.

Is the proposed project potentially susceptible to hydromodification impacts?

Yes No (show map)

As part of the 2011 Model WQMP, channels susceptible to hydromodification were analyzed for each watershed. Figure XVI-3c of the Technical Guidance Document (May 2011) demonstrates that the project location does not fall within an area susceptible to hydromodification. This is primarily due to the fact the project drains into tidally influenced receiving water bodies which are less susceptible to hydromodification impacts. In addition, a majority of the project site drains into the lowlands area of the site which is a flat low-lying area that allows storm flows to disperse into a series of sump conditions which is less susceptible to channel scour and erosion.

For the portion of the project site that drains into a more defined natural channel (Southern Arroyo and Semeniuk Slough), additional calculations were performed. In order to demonstrate the changes in runoff as a result of the proposed project, a variety of analyses were calculated including net volume, peak flow and Time of Concentration (T_c) for the 2-year, 24-hour storm event for existing and proposed conditions for areas tributary to the Semeniuk Slough (including contributions from the Caltrans box culvert drainage area). The following table originates from the Newport Banning Ranch Watershed Assessment Report dated June 30, 2011 (Table 4.3, DEIR Appendix C).

SEMENIUK SLOUGH PROPOSED CONDITION RUNOFF VOLUME (EV EVENTS)			
Sub-Watershed	Drainage Area (acres)	2-Year Volume (ac-ft)	100-Year Volume (ac-ft)
"A"	322.0	18.3	81.2
"F"	5.8	0.5	1.6
"G"	1.8	0.2	0.5
"H"	7	0.6	1.9
"I"	1.1	0.1	0.3
"J"	11	0.9	3.0
"K"	6.3	0.5	1.7
Salt Marsh Basin	54	6.5	20.2
Total	409.0 (-27.6)	27.6 (+1.0)	110.4 (-4.0)
PROPOSED CONDITION PEAK FLOW RATE (EV EVENTS)			
Location	Drainage Area (acres)	2-Year Peak Flow (cfs) / Tc ^b	100-Year Peak Flow (cfs)
Node 19 (upstream)	145.8 (-9.3)	72.7 (-8.1) / 19.54 (+0.03)	302.2 (-21.2)
Node 23 (downstream)	322.0 (-27.6)	128.1 (+6.8) / 37.51 (+0.06)	513.9 (+12.7)
Note: Numbers in parentheses represent change as compared to existing condition. cfs - cubic feet per second a For the Salt Marsh area, the runoff volume is estimated by the following: Precipitation (in) x Area (ac) / 12 b Tc = Time of Concentration noted for 2-year event per Section XII.D of fourth-term MS4 Storm Water Permit			

Based on the analysis, the results demonstrate the 2-year will increase 1.0 cf between existing and proposed which is less than 5% change from the existing condition (3.7%). In addition, Time of Concentrations (Tc) will also remain within 5% of existing conditions. Therefore, the Project does not have a hydrologic condition of concern for flows directed to the Semeniuk Slough.

Lastly, to further protect existing drainage channels, both the Southern Arroyo and Northern Arroyo drainage courses were analyzed to determine existing flow rates, channel hydraulics and tributary drainage areas. Through grading and storm drain design objectives, these existing conditions were maintained under the proposed condition to reduce the potential for long-term channel degradation within the Southern and Northern Arroyo. See Newport Banning Ranch Watershed Assessment Report dated June 30, 2011 (Section 3.3, DEIR Appendix C).

II.4 POST DEVELOPMENT CHARACTERISTICS

The proposed condition contains six primary on-site storm drain systems that will drain Project flows to downstream receiving water bodies. They are described below as follows:

- **Storm Drain A (Drainage Area “A”):** Discharges to the existing Caltrans box culvert under the West Coast Highway (WCH). Storm Drain A (SD-A) is designed to reduce the tributary drainage area of this storm drain system as compared to the existing condition to account for the increase in Project runoff in the proposed condition.
- **Storm Drains B and C (Drainage Area “A”):** Collect flows from the development areas adjacent to the Southern Arroyo and delivers these flows to a diffuser basin located downstream of the Arroyo adjacent to the Semeniuk Slough. The design of Storm Drains B and C (SD-B, SD-C) serves three primary functions: 1) to minimize the discharge of storm water flows directly to the Arroyo channel to protect the long-term channel stability, 2) dissipate erosive energy before flows enter the Semeniuk Slough, and 3) control sediment contributions to the Semeniuk Slough.
- **Storm Drains D and E (Drainage Area “C”):** Collect flows from the larger development areas of the Project and delivers storm flows to the Lowland Area. Under the existing conditions, a portion of drainage from Storm Drain D (SD-D) is tributary to the Southern Arroyo and Semeniuk Slough. The proposed drainage re-direction is specifically designed to maximize the amount of flow to be directed towards the Lowland Area in order to reduce the flood loading of the Semeniuk Slough. A second diffuser basin will be installed downstream of Storm Drains D and Storm Drain E (SD-E) to reduce the momentum of the flows from the pipes and to spread the distribution of runoff to the Lowland in a manner that will enable future habitat restoration efforts.
- **Storm Drain F (Drainage Area “B”):** Collects flows from the northernmost development area. The tributary drainage area has been designed to match existing runoff conditions to the Northern Arroyo. An energy dissipater will be installed at the outlet to Storm Drain F (SD-F) to transition flows from erosive velocities to mild velocities, and to deliver non-erosive flows to the natural channel.
- **Storm Drain G (Drainage Area “D”):** Collects flows from the northerly most portion of the northern development area. Flow in Storm Drain G (SD-G) is delivered to the Lowland Area via a culvert and a storm drain located in the new Bluff Road roadway extension to 19th Street.

II.5 PROPERTY OWNERSHIP/MANAGEMENT

PROPERTY OWNERSHIP/MANAGEMENT	
Public Streets:	City of Newport Beach
Private Streets:	HOA
Landscaped Areas:	Public Areas: City of Newport Beach Private Areas: HOA / Individual Homeowner / Resort Operator
Open Space:	Conservation Entity / HOA
Easements:	Orange County Sanitation District , Standard Oil & Gas Co. Oil Easements, City of Newport Beach, State of California (per TTM 17308)
Parks:	Public Parks: City of Newport Beach Private Parks: HOA
Buildings:	HOA / Individual Homeowners / Resort Operator
Oil Consolidation Sites	Oil Operator

PROPERTY OWNERSHIP/MANAGEMENT	
Structural BMPs:	Public Areas: City of Newport Beach Private Areas: HOA

A Home Owners Association (HOA) will be formed upon project completion. The HOA will be responsible for inspecting and maintaining all BMPs prescribed for Newport Banning Ranch. Until a HOA is formally established, Newport Banning Ranch, LLC shall assume all BMP maintenance and inspection responsibilities for the proposed project. Inspection and maintenance responsibilities are outlined in Section V of this report.

The City of Newport Beach shall assume all BMP maintenance and inspection responsibilities for the public streets and public park areas of the proposed project.

Inspection and maintenance responsibilities for structural BMPs are outlined in Section V of this report.

SECTION III SITE DESCRIPTION

III.1 PHYSICAL SETTING

Planning Area/ Community Name	Newport Banning Ranch
Location/Address:	North of West Coast Highway (WCH), south of 19 th Street, east of the Santa Ana River channel, and west of the cities of Newport Beach and Costa Mesa. 5200 West Coast Highway, Newport Beach CA 92663
Project Area Description	The Newport Banning Ranch Project site encompasses approximately 401.1 acres. Approximately 40 acres of the Project site are located within the incorporated boundary of the City of Newport Beach; the remainder of the Project site is located within unincorporated Orange County, in the City's adopted Sphere of Influence. The entire Project site is within the boundary of the Coastal Zone, as established by the California Coastal Act.
Land Use:	Current: Oil Extraction Proposed: Residential, Park, Oil Extraction/Open Space, Commercial, Coastal Inn
Zoning:	Per the Newport Banning Ranch Planned Community
Acreage:	401.1 gross ac
Predominant Soil Type:	C (northern portions primarily within Lowlands) D (entire mesa area) A (southern portion)

III.2 SITE CHARACTERISTICS

Precipitation Zone:	0.7 inch Design Capture Storm
Topography:	<p>Within the project boundary, there are several primary landforms of concern that are referenced throughout this report:</p> <ul style="list-style-type: none"> ▪ Lowland Area: Located in the northeasterly portion of the property, and currently consists of degraded wetland and ruderal vegetation, as well as roads, pipelines, and other facilities associated with oil operations. The Lowland Area also consists of several narrow channels and shallow depressions. ▪ Upland Mesa: Located in the eastern portion of the property, and currently consists of existing pipelines, roads, buildings, and other equipment related to oil extraction activities. ▪ Bluffs: Located adjacent to the Lowland Area and include west and southwest facing slopes of varying steepness.

	<ul style="list-style-type: none"> ▪ Arroyos: There are several existing drainage courses (generally referred to as “Arroyos”) that fall gradually from the eastern project boundary across the Mesa and Bluffs towards the Semeniuk Slough in the western portion of the site. The two largest Arroyos, designated as the Northern and Southern Arroyos, are considered significant drainage features and convey runoff from upstream areas (primarily off-site contributions) through the project site. ▪ Semeniuk Slough (Oxbow Loop): Consists of a meandering drainage course that flanks the southern portion of the site. The Semeniuk Slough, also known as Oxbow Loop or Newport Slough, receives runoff from both on-site and off-site areas, and drains generally west and north towards the Lowland Area. However, a small dike separates the Lowland Area from the Semeniuk Slough channel, and there are several culverts that allow for tidal exchange between the areas.
<p>Drainage Patterns/Connections:</p>	<p>Proposed drainage conditions are discussed in Section II.4 of this report.</p>
<p>Soil Type, Geology, and Infiltration Properties:</p>	<p>Within the vicinity of the project site, three general soil units are present: San Pedro Formation bedrock, marine terrace deposits, and river alluvium. The San Pedro Formation bedrock generally consists of gray and dark gray to reddish yellow-stained siltstone and clayey siltstone, with sandstone interbeds. The marine terrace deposits generally consist of rounded cobbles, shells, and angular rocks similar to materials found in tidal zones. Both the bedrock and marine terrace deposits occur beneath the Mesa and elevated portions of the project site. Soils within the Lowland Area of the site are primarily alluvium, which consist of relatively young sediments of gravel, sand, and clay deposits. In addition, artificial fill is located throughout the site, mainly associated with the construction of the on-site oil facilities.²</p>
<p>Hydrogeologic (Groundwater) Conditions:</p>	<p>Within the vicinity of the project site, groundwater elevation is generally at mean sea level within the Lowland and Upland areas, and perched groundwater above mean sea level may exist sporadically within the Upland. Within the Lowlands, groundwater is roughly 5-10 feet below existing grade. Throughout portions of the site, groundwater may become perched due to presence of clay layers and/or bedrock.</p>
<p>Geotechnical Conditions (relevant to infiltration):</p>	<p>Infiltration on the project site may be limited or infeasible in certain regions due to geotechnical concerns and presence of shallow groundwater. Within the upper Mesa, soils generally consist of sandy marine deposits underlain by bedrock (San Pedro formation) and overlain by silty to sandy clays. Given the above soil stratigraphy, shallow infiltration would be precluded due to low infiltration of the upper soil zone and future engineered fills. Deep infiltration into the bedrock is likewise also not feasible. Infiltration below the upper fine</p>

² GMU Geotechnical, Inc. Report of Geotechnical Studies. Proposed Newport Banning Ranch Development, City of Newport Beach/County of Orange. Draft March 2008.

	<p>grained zone into the Marine Terrace deposits is feasible from an infiltration perspective. However, seepage into this zone would “perch” on top of the bedrock and flow towards the bluff face (see Exhibit A in Appendix F of this P-WQMP) causing local slope instability. The local bluff stability would also lead to increased rates of erosion potentially damaging proposed improvements.</p> <p>Within the Lowlands, soils generally consist of alluvial deposits (Group A soils) with areas containing lenses of finer grained sandy silts to silty clay (Group B to D soils). However, the groundwater table is largely within a few feet of the existing topographic grade. In these locations, infiltration of runoff in these soils may be limited.</p>
Off-Site Drainage:	Off-site drainage from the existing urban areas of the cities of Costa Mesa and Newport Beach enter the project site through storm drain culverts at the upstream ends of the Arroyos.
Utility and Infrastructure Information:	<p>There are existing utility easements along portions of the project site for the City of Newport Beach and Orange County Sanitation District. Existing easements are outlined on TTM 17308, a copy of which is included in Section VI.</p> <p>The Project proposes approximately 16.5 gross acres of the open space area as Interim Oil Facilities. As a part of the proposed Project, the Applicant would abandon and remediate the existing surface oil operations within the Project site to consolidate the oil facilities into approximately 16.5 gross acres.</p>

III.3 WATERSHED DESCRIPTION

Receiving Waters:	Semeniuk Slough (also known as Oxbow Loop or Newport Slough)								
303(d) Listed Impairments:	Newport Slough: Enterococcus, Fecal Coliform, Total Coliform (2010)								
Applicable TMDLs:	None								
Pollutants of Concern for the Project:	<table> <tr> <td>Suspended Solid/ Sediment</td> <td>Pesticides</td> </tr> <tr> <td>Nutrients</td> <td>Oil & Grease</td> </tr> <tr> <td>Heavy Metals</td> <td>Toxic Organic Compounds</td> </tr> <tr> <td>Pathogens (Bacteria/Virus)</td> <td>Trash & Debris</td> </tr> </table>	Suspended Solid/ Sediment	Pesticides	Nutrients	Oil & Grease	Heavy Metals	Toxic Organic Compounds	Pathogens (Bacteria/Virus)	Trash & Debris
Suspended Solid/ Sediment	Pesticides								
Nutrients	Oil & Grease								
Heavy Metals	Toxic Organic Compounds								
Pathogens (Bacteria/Virus)	Trash & Debris								
Environmentally Sensitive and Special Biological Significant Areas:	<p>Portions of the project site drain to Semeniuk Slough (aka. Newport Slough), which is listed as impaired for bacteria indicators on the CWA Section 303(d) list, and therefore is considered and ESA.</p> <p>The entire project site is within the Coastal Zone as defined by the Coastal Act.</p> <p>Approximately 53.76 acres of USACE jurisdictional areas occur on site, of which 53.15 acres consist of jurisdictional wetlands. The Project's Master Development Plan designates a minimum of 220 gross acres of the Project site as wetland restoration/water quality areas, habitat restoration areas, and habitat preservation areas.</p>								

SECTION IV BEST MANAGEMENT PRACTICES (BMPs)

IV.1 PROJECT PERFORMANCE CRITERIA

Is there an approved WIHMP or equivalent for the project area that includes more stringent LID feasibility criteria or if there are opportunities identified for implementing LID on regional or sub-regional basis?

Yes No

PROJECT PERFORMANCE CRITERIA	
Hydromodification Control Performance Criteria (Model WQMP Section 7.II-2.4.2.2)	The volumes and time of concentration of storm water runoff for the post-development condition do not significantly exceed those of the predevelopment condition for a two-year frequency storm event (a difference of five percent or less is considered insignificant).
LID Performance Criteria (Model WQMP Section 7.II-2.4.3)	Infiltrate, harvest and use, evapotranspire, or biotreat/biofilter, the 85 th percentile, 24-hour storm event (Design Capture Volume). LID BMPs must be designed to retain, on-site, (infiltrate, harvest and use, or evapotranspire) storm water runoff up to 80 percent average annual capture efficiency
Treatment Control BMP Performance Criteria (Model WQMP Section 7.II-3.2.2)	If it is not feasible to meet LID performance criteria through retention and/or biotreatment provided on-site or at a sub-regional/regional scale, then treatment control BMPs shall be provided on-site or offsite prior to discharge to waters of the US. Sizing of treatment control BMP(s) shall be based on either the unmet volume after claiming applicable water quality credits, if appropriate.
LID Design Storm Capture Volume	Total development area 149.42 ac (excludes off-site tributary, oil consolidation site & open space areas) ~64% impervious DCV = 240,992 ft ³ (5.53 ac-ft)

IV.2 SITE DESIGN AND DRAINAGE PLAN

The following section describes the site design BMPs used in this project and the methods used to incorporate them. Careful consideration of site design is a critical first step in storm water pollution prevention from new developments and redevelopments.

IV.2.1 Site Design BMPs

Minimize Impervious Area

Dry weather flows and low flows from the project development areas will be routed through low impact development (LID) BMPs with vegetation and/or infiltration characteristics in accordance with the Model WQMP criteria.

Maximize Natural Infiltration Capacity

Although infiltration will be limited in the Upland Mesa development areas, there are opportunities for dispersion and infiltration of storm water runoff in the Lowlands portion of the project site. Consistent with existing drainage patterns, the majority of the project drainage will be directed towards the Lowlands which has the highest infiltration potential within the project boundary.

Preserve Existing Drainage Patterns and Time of Concentration

Under the existing conditions, storm flows drain to either the Semeniuk Slough or the Lowlands before ultimately discharging into the Santa Ana River. Under the proposed conditions, storm water runoff will continue to drain into the Slough and Lowlands. Existing drainage patterns will be maintained and Time of Concentrations will be preserved to the existing drainage channels and receiving waters. In order to maintain existing runoff volumes to the Slough and maintain existing flood protection, a portion of drainage will be diverted to the Lowlands which has capacity to accept the additional drainage.

Disconnect Impervious Areas

Impervious surfaces have been minimized by incorporating landscaped areas over substantial portions of the site including common areas, parkways, medians, in addition to larger parks and open space areas. The streets and sidewalks will be designed with minimum width requirements to minimize impervious surfaces where feasible.

Protect Existing Vegetation and Sensitive Areas, and Revegetate Disturbed Areas

Approximately 235.8 acres will be retained as open space. Native trees and shrubs will be preserved in natural open space areas and native or drought tolerant plants will be used in development plant palettes.

IV.2.2 Drainage Management Areas

In accordance with the MS4 permit and the new Model WQMP, the Design Capture Volumes (DCVs) presented in the following table represent the minimum volume of storm water runoff required to be treated by LID and/or treatment control BMPs for the proposed project. The total DCV noted in the table represents the treatment requirement for all of the development areas. Preliminary footprints and depths required by each BMP are summarized in the following sections. Detailed calculations are provided in Appendix A. Final design and calculations will be identified and documented during project Final WQMP development.

DEVELOPMENT DRAINAGE MANAGEMENT AREAS							
Drainage Area ID	Land Use Type	% impervious	Runoff Coefficient	Design Storm Depth (in)	Drainage Area (ac)	DCV (ft ³)	BMP Type
WCH Tributary - Storm Drain A							
A19.4	Community Park	15%	0.26	0.7	3.90	2,616	Bioretention
A19.2	Community Park	15%	0.26	0.7	6.81	4,568	Bioretention

DEVELOPMENT DRAINAGE MANAGEMENT AREAS							
Drainage Area ID	Land Use Type	% impervious	Runoff Coefficient	Design Storm Depth (in)	Drainage Area (ac)	DCV (ft ³)	BMP Type
A7.3	Community Park	15%	0.26	0.7	4.18	2,804	Bioretention
South Arroyo Tributary - Southerly Drainage Areas (Storm Drain B)							
TOTAL	--	68.24%	0.66	0.7	33.47	56,412	Bioretention
South Arroyo Tributary - Northerly Drainage Areas (Storm Drain C)							
TOTAL	--	65.39%	0.64	0.7	22.94	37,417	Bioretention
Lowlands Tributary - West of "B" Street (Storm Drain D)							
TOTAL ⁽¹⁾	--	66.28%	0.65	0.7	55.43	91,356	Bioretention
Lowlands Tributary - East of "B" Street (Storm Drain E)							
C12.2	Mixed Use/ Residential	80%	0.75	0.7	5.11	9,758	Bioretention
Lowlands Tributary - Storm Drain F							
B11.1	Mixed Use/ Residential	80%	0.75	0.7	4.57	8,727	Bioretention
Arterial Streets w/ Landscaped Biocells (stand alone - not included in drainage areas above)							
A19.1	Arterial Road	90%	0.83	0.7	1.09	2,289	LS Biocell
A19.3	Arterial Road	90%	0.83	0.7	1.58	3,318	LS Biocell
A19.5	Arterial Road	90%	0.83	0.7	2.93	6,153	LS Biocell
A19.7	Arterial Road	90%	0.83	0.7	2.52	5,292	LS Biocell
A7.5	Arterial Road	90%	0.83	0.7	1.9	3,990	LS Biocell
B11.3	Arterial Road	90%	0.83	0.7	2.21	4,641	LS Biocell
D3.2	Arterial Road	90%	0.83	0.7	2.72	5,712	LS Biocell
Water Quality Detention Basin for Off-Site Runoff							
TOTAL	--	86.67%	0.80	0.7	47.81	97,370	Detention Basin
Total Development Area ⁽²⁾	--	64.43%	0.63	0.7	149.4	240,992	--

Notes:

1. Includes 1.94 acres of upstream, off-site tributary area.
2. Excludes tributary from off-site drainage areas in Storm Drain D, open space areas, and oil consolidation sites.

IV.3 LID BMP SELECTION AND PROJECT CONFORMANCE ANALYSIS

Low Impact Development (LID) BMPs are required in addition to site design measures and source controls to reduce pollutants in storm water discharges. LID BMPs are engineered facilities that are designed to retain or biotreat runoff on the project site. The 4th Term MS4 Storm Water Permit (Order R9-2009-0009) requires the evaluation and use of LID features using the following hierarchy of

treatment: infiltration, evapotranspiration, harvest/reuse, and biotreatment. The following sections summarize the LID BMPs proposed for the project in accordance with the permit hierarchy and performance criteria outlined in Section IV.1.

IV.3.1 Hydrologic Source Controls (HSCs)

Hydrologic source controls (HSCs) can be considered to be a hybrid between site design practices and LID BMPs. HSCs are distinguished from site design BMPs in that they do not reduce the tributary area or reduce the imperviousness of a drainage area; rather they reduce the runoff volume that would result from a drainage area with a given imperviousness compared to what would result if HSCs were not used.

HYDROLOGIC SOURCE CONTROLS		
ID	Name	Included?
HSC-1	Localized on-lot infiltration	<input type="checkbox"/>
HSC-2	Impervious area dispersion (e.g. roof top disconnection)	<input type="checkbox"/>
HSC-3	Street trees (canopy interception)	<input type="checkbox"/>
HSC-4	Residential rain barrels (not actively managed)	<input type="checkbox"/>
HSC-5	Green roofs/Brown roofs	<input type="checkbox"/>
HSC-6	Blue roofs	<input type="checkbox"/>
HSC-7	Impervious area reduction (e.g. permeable pavers, site design)	<input type="checkbox"/>

HSC's will be accounted for during final design and the cumulative volume of the HSC's will be subtracted from the required treatment volume in the Final WQMP.

IV.3.2 Infiltration BMPs

Infiltration BMPs are LID BMPs that capture, store and infiltrate storm water runoff. These BMPs are engineered to store a specified volume of water and have no design surface discharge (underdrain or outlet structure) until this volume is exceeded. Examples of infiltration BMPs include infiltration trenches, bioretention without underdrains, drywells, permeable pavement, and underground infiltration galleries.

INFILTRATION		
ID	Name	Included?
INF-3	Bioretention Without Underdrains	<input type="checkbox"/>
INF-4	Rain Gardens	<input type="checkbox"/>

INFILTRATION		
ID	Name	Included?
	Porous Landscaping	<input type="checkbox"/>
	Infiltration Planters	<input type="checkbox"/>
	Retention Swales	<input type="checkbox"/>
INF-2	Infiltration Trenches	<input type="checkbox"/>
INF-1	Infiltration Basins	<input type="checkbox"/>
INF-5	Drywells	<input type="checkbox"/>
INF-7	Subsurface Infiltration Galleries	<input type="checkbox"/>
--	French Drains	<input type="checkbox"/>
INF-6	Permeable Asphalt	<input type="checkbox"/>
	Permeable Concrete	<input type="checkbox"/>
	Permeable Concrete Pavers	<input type="checkbox"/>
	Other:	<input type="checkbox"/>

As discussed under Section III.2, infiltration within the Mesa development areas will be limited due to the presence of bedrock may cause perched groundwater to flow towards the bluff face and cause local slope instability. Although infiltration in portions of the Lowlands may be feasible, the areas may be limited due to presence of high groundwater and localized areas with clay soils. As a result, infiltration of the entire project design capture volume is considered infeasible.

Although the general or broad use of infiltration has been determined infeasible as an LID approach for the Newport Banning Ranch project at the CEQA level, there may prove to be limited opportunities to implement infiltration on a more local or micro scale as a hydrologic source control. The use of infiltration in this regard will be determined during later stages in the project's design, and subsequent infiltration studies will be provided in Appendix F of the Final WQMP.

IV.3.3 Evapotranspiration, Rainwater Harvesting BMPs

Evapotranspiration BMPs are a class of retention BMPs that discharges stored volume predominately to ET, though some infiltration may occur. ET includes both evaporation and transpiration, and ET BMPs may incorporate one or more of these processes. BMPs must be designed to achieve the maximum feasible ET, where required to demonstrate that the maximum amount of water has been retained on-site. Since ET is not the sole process in these BMPs, specific design and sizing criteria have not been developed for ET-based BMPs.

EVAPOTRANSPIRATION		
ID	Name	Included?
--	HSCs, see Section IV.3.1	<input type="checkbox"/>
--	Surface-based infiltration BMPs	<input type="checkbox"/>
--	Biotreatment BMPs, see Section VI.3.4	<input type="checkbox"/>
	Other:	<input type="checkbox"/>

Bioretention BMPs are proposed which utilize evapotranspiration as physical process for runoff volume reduction. Bioretention BMPs are described further in Section IV.3.4.

Harvest and use (aka. Rainwater Harvesting) BMPs are LID BMPs that capture and store storm water runoff for later use. These BMPs are engineered to store a specified volume of water and have no design surface discharge until this volume is exceeded. Harvest and use BMPs include both above-ground and below-ground cisterns. Examples of uses for harvested water include irrigation, toilet and urinal flushing, vehicle washing, evaporative cooling, industrial processes and other non-potable uses.

HARVEST & REUSE / RAINWATER HARVESTING		
ID	Name	Included?
HU-1	Above-ground cisterns and basins	<input type="checkbox"/>
HU-2	Underground detention	<input type="checkbox"/>
--	Other:	<input type="checkbox"/>

In order to evaluate the feasibility of harvest and use, the Technical Guidance Document (TGD), dated May 19, 2011 provides a two-step process to determine feasibility and applicability to the proposed project. Step 1 is the initial screening and is found within Appendix X of the TGD, and Steps 2 and 3 are more detailed assessments, either of which may be used and are found within the BMP Fact Sheets (XIV.4 Harvest and Use – HU).

Step 1: Determine if the Project Meets the Minimum Harvested Water Demand Threshold

In order to quantify harvested water demand, the Modified Estimated Applied Water Use (EAWU) method was used, consistent with Appendix X of the Model WQMP’s Technical Guidance Document (TGD), dated May 19, 2011. The Modified EAWU method is modified from the OC Irrigation Code (County Ordinance No. 09-010) to account for the wet season demand and storm events (assuming that no irrigation would be applied for approximately 30% of the days in the wet season).

The equation used to calculate the Modified EAWU is:

$$\text{Modified EAWU} = \frac{(ETo_{wet} \times K_L \times LA \times 0.015)}{IE}$$

Where:

- Modified EAWU* = estimated daily average water use during wet season
- ETo_{wet}* = average reference ET from November through April (inches per month) per Table X.2 of the TGD
- K_L* = landscape coefficient (Table X.4 of the TGD)
- LA* = landscape area irrigated with harvested water (square feet)
- IE* = irrigation efficiency (assumed at 90%)

Note: In the equation, the coefficient (0.015) accounts for unit conversions and shut down of irrigation during and for three days following a significant precipitation event.

For a system to be considered “feasible”, the system must be designed with a storage volume equal to the DCV from the tributary area and achieve more than 40% capture. The system must also be able to drawdown in 30 days to meet the 40% capture value. In addition, Table X.6 of the Technical Guidance Document sets forth the demand thresholds for minimum partial capture.

TABLE X.6: HARVESTED WATER DEMAND THRESHOLDS FOR MINIMUM PARTIAL CAPTURE	
Design Capture Storm Depth, inches	Wet Season Demand Required for Minimum Partial Capture, gpd per impervious acre
0.60	490
0.65	530
0.70	570
0.75	610
0.80	650
0.85	690
0.90	730
0.95	770
1.00	810

Several of the land use and/or product types proposed for the Newport Banning Ranch project were evaluated using typical impervious/pervious land area ratios and planting types to estimate the feasibility for harvest and reuse systems on-site. Although specific irrigated areas and landscaping types are not available at this time, assumptions can be made based on similar product types and associated landscaping irrigation demands.

The following table summarizes the estimated applied water use for these areas of the project.

STEP 1: ESTIMATED APPLIED WATER USE (EAWU) FOR COMMON AREA LANDSCAPING												
Land Use & Landscape Type	Total Area (ac)	% Impervious	Impervious Tributary (ac)	Irrigated LS Area (sf)	DCV (gal)	ET _{owet} ⁽¹⁾ (in/mo)	K _L ⁽²⁾	Modified EAWU (gpd)	Modified EAWU per impervious acre (gpd/ac)	Minimum Capture Threshold ⁽³⁾ (gpd/ac)	Drawdown (days)	Meet Minimum Feasibility Threshold?
1 Single Family 4,000 ft ² lot 40% Active Turf	0.092	60%	0.055	1,600	1,047.2	2.75	0.7	51.3	931.7	610	20.4	Yes
Attached Condos 15% Conservation Design Landscape	2.0	85%	1.70	13,068	29,935.5	2.75	0.35	209.6	123.3	610	142.8	No
Community Park 80% Active Turf	4.1	20%	0.82	142,876	23,378.2	2.75	0.7	4,583.9	5,590.2	610	5.1	Yes
Notes:												
1 Per Table X.2 for Laguna Beach Region (similar climate type), Model WQMP Technical Guidance Document, dated May 19, 2011.												
2 Per Table X.4 of the Model WQMP Technical Guidance Document, dated May 19, 2011.												
3 Per Table X.6 of Model WQMP Technical Guidance Document, dated May 19, 2011.												

Based on the results of the Step 1 minimum threshold analysis, harvest and use is considered feasible for the following product types: traditional single-family lot detached and recreational park uses. Harvest and use is not considered feasible for condominium uses as the irrigation demand is insufficient to meet the minimum harvest demand threshold. With attached condominiums, a typical lot is approximately 85% impervious, with 15% landscaping primarily consisting of “conservation design”, which is defined as “non-active turf” in the TGD. Under this scenario, the conservation landscaping utilizes less water for irrigation, and thus has a lower demand and the system would not be able to draw down within the 30 days required for feasibility. Similarly, the resultant irrigated area to tributary impervious area is below the minimum threshold for capture feasibility. As a result, harvest and reuse is not recommended for attached condominiums and land uses with similar landscape design and imperviousness, such as mixed use, commercial and retail developments.

In accordance with the TGD, if the project meets or exceeds the minimum harvested water demand thresholds, continue to Step 2 or Step 3 (both are considered equally-allowable pathways) using the BMP Fact Sheets (XIV.4. Harvest and Use BMP Fact Sheets HU). The Step 2 “pathway” requires the cistern volume be sized to result in an 80% capture of average annual runoff volume. This particular sizing requirement is not feasible for either land use (single family home / park) because the 80% capture efficiency method would result in significantly larger sizing volumes than the DCV based on the fact the drawn downs are significantly greater than 48 hours. Reliance on a cistern only for 80% capture of average annual runoff volume is considered infeasible. Therefore, the Step 3 “pathway” was analyzed for determining cistern volume and drawdown to achieve maximum practicable capture efficiency.

Step 3: Determine Cistern Volume and Drawdown to Achieve Maximum Practicable Capture Efficiency

In accordance with the TGD, Step 3 computes the maximum feasible fraction of storm water that can be retained with harvest and use BMPs. The following steps and decision criteria are provided:

- Compute the drawdown time of the cistern as follows:

$$\text{Drawdown Time (hr)} = \frac{\text{Volume (ft}^3\text{)} \times 7.48 \frac{\text{gal}}{\text{ft}^3} \times 24 \frac{\text{hr}}{\text{day}}}{\text{Demand} \left(\frac{\text{gal}}{\text{day}}\right)}$$

- Based on the DCV and the drawdown time, calculate the long term average capture efficiency using the Capture Efficiency Method for Volume-based, constant drawdown BMPs (TGD Appendix III.3.2).
- If capture efficiency is less than 40%, harvest and use is not required to be considered for use on the project.
- If capture efficiency is greater than 40%, provide a cistern sized for the DCV and provide volume or flow rate to treat the remaining volume up to 80 percent total average annual capture using biotreatment BMP.

Capture efficiency was evaluated for the single family residential lots and community parks. Results are summarized below:

STEP 3: PRACTICAL CAPTURE EFFICIENCY FOR COMMON AREA LANDSCAPING						
Land Use & Landscape Type	Total Area (ac)	DCV ⁽¹⁾ (ft ³)	Demand ⁽¹⁾ (EAWU, in gpd)	Drawdown (hr)	% Capture Efficiency ⁽²⁾	Meet Minimum Capture Efficiency?
1 Single Family 4,000 ft ² lot 40% Active Turf	0.092	140.0	51.3	489	47%	Yes
Community Park 80% Active Turf	4.1	3,125.4	5,590.2	100	68%	Yes

Notes:
 1. Per Step 1.
 2. Per Appendix III.3.2 and Figure III.2 of the Model WQMP Technical Guidance Document, dated May 19, 2011.

Based on this Partial Capture Efficiency Evaluation, the single family detached residential lots meets the minimum 40% capture efficiency requirements (47%) and harvest and use is required to be considered for this land use with the development. However significant obstacles to implementation and maintenance occur with this specific land use. For example, the DCV for a single family lot is approximately 150 cubic feet of runoff, or 1,122 gallons, which far exceeds the capacity of the 55-gallon rain barrels commonly utilized for single-family residences. In this situation, 20 rain barrels would be needed at 55 gallons each in order to capture the DCV for one 4,000 square foot lot, which is not practical for one single family residence of that size. In addition, placing a cistern underground would create excess infrastructure including pump systems, larger filtration systems and back-up irrigation systems for each lot. Further, implementing harvest and reuse at the single-family lot scale would place the reuse of the storm water and maintenance of the system burden on the homeowner, which may be difficult to enforce over time. Although harvest and reuse of the entire design capture volume for each residence is not practical, this does not preclude the developer from offering the 55-gallon rain barrels as a sustainable option for those homeowners interested in reducing runoff, reusing storm water and decreasing potable water consumption.

For the recreational park uses, the estimated capture efficiency of 68% exceeds the 40% threshold and harvest and use must be considered feasible for these land uses. It's important to note this evaluation assumes the parks are designed with primarily turf grass requiring higher water demands and does not account for any off-site tributary development areas surrounding the parks. Implementation of less turf grass and more water conserving landscaping will lower the estimated capture efficiency. If harvest and use was evaluated to factor in runoff from the surrounding neighborhood developments, the design capture volume would greatly exceed the landscaping demand and the capture efficiency would drop below the 40% threshold. Therefore, harvest and use systems should only be considered feasible within the park drainage areas only with sufficient turf grass.

Based on the results of this analysis, the following findings can be concluded:

- Single family lots exhibit sufficient irrigation demand using the initial feasibility screening assessment (Step 1) and meet the minimum capture efficiency evaluation (47%) in accordance with the TGD (Step 3). Therefore, harvest and use systems should be considered feasible for further consideration based on irrigation demand only. However, this land use presents significant obstacles to harvest and reuse implementation including spatial constraints of single family detached homes which limits a consolidated or centralized subterranean storage system and requires individual storage units per home. In addition, if rain barrels are used the

quantity required for the DCV come prohibitive (>20 55-gallon barrels/home) and requires additional plumbing infrastructure and reliance on individual homeowners to maintain these systems. Rain barrels should be available as an option for homeowners to support water harvesting objectives on a smaller scale

- Higher density product types such as condos or alley-loaded attached units do not exhibit sufficient irrigation demand using the initial feasibility screening (Step 1) and harvest and reuse is considered infeasible.
- Park areas within the proposed development exhibit sufficient irrigation demand and can be designed with the proper storage infrastructure (likely subterranean) to accommodate harvest and reuse systems. Harvest and reuse systems are considered feasible for such land uses and should be sized to the Design Capture Volume. Biotreatment should be utilized to treat the remainder of the 80% capture efficiency volume.

IV.3.4 Biotreatment BMPs

Biotreatment BMPs are a broad class of LID BMPs that reduce storm water volume to the maximum extent practicable, treat storm water using a suite of treatment mechanisms characteristic of biologically active systems, and discharge water to the downstream storm drain system or directly to receiving waters. Treatment mechanisms include media filtration (though biologically-active media), vegetative filtration (straining, sedimentation, interception, and stabilization of particles resulting from shallow flow through vegetation), general sorption processes (i.e., absorption, adsorption, ion-exchange, precipitation, surface complexation), biologically-mediated transformations, and other processes to address both suspended and dissolved constituents. Examples of biotreatment BMPs include bioretention with underdrains, vegetated swales, constructed wetlands, and proprietary biotreatment systems.

BIOTREATMENT		
ID	Name	Included?
BIO-1	Bioretention with underdrains	<input checked="" type="checkbox"/>
	Storm Water planter boxes with underdrains	<input type="checkbox"/>
	Rain gardens with underdrains	<input checked="" type="checkbox"/>
BIO-5	Constructed wetlands	<input type="checkbox"/>
BIO-2	Vegetated swales	<input checked="" type="checkbox"/>
BIO-3	Vegetated filter strips	<input type="checkbox"/>
BIO-7	Proprietary vegetated biotreatment systems	<input type="checkbox"/>
BIO-4	Wet extended detention basin	<input type="checkbox"/>
BIO-6	Dry extended detention basins	<input type="checkbox"/>
--	Other:	<input type="checkbox"/>

In accordance with the 2011 Model WQMP, a properly designed biotreatment system may only be considered if infiltration, harvest and reuse, and evapotranspiration (ET) cannot be feasibly implemented for the full design capture volume. In this case, infiltration, harvest and reuse, and ET practices must be implemented to the greatest extent feasible and biotreatment may be provided for the remaining design capture volume.

For the purposes of the CEQA impact assessment provided in the project DEIR, biotreatment BMPs in the form of landscaping biocells and larger bioretention cells were assumed to serve as a primary mechanism to demonstrate the Project's ability to treat the required design capture volume per the fourth-term MS4 Permit.

Parkway Landscaping Biocells

The primary features proposed for the larger, arterial streets are referred to as landscaping biocells, which will be incorporated into select portions of the parkway bioswales identified in the arterial and collector street cross sections on the Tentative Tract Map No. 17308. These features function as a soil and plant-based filtration device that removes pollutants through a variety of physical, biological, and chemical treatment processes. The major treatment of runoff occurs through the percolation of runoff through several layers of the biocell within the parkway bioswale prior to either infiltrating into the ground (if feasible) or collected by sub-drains and returned back to the storm drain system. Landscaping biocells are typically sized based on the water stored within the cell and the amount of water filtering through the biocell during storm events.

Biocells function similarly in nature to bioretention cells and rain gardens but tend to have shallower depths based on a higher reliance on sand-based soil amendments. Biocells remove storm water pollutants through processes such as adsorption, filtration, plant uptake, microbial activity, decomposition, sedimentation and volatilization.³ Adsorption is the process whereby particulate pollutants attach to soil (e.g., clay) or vegetation surfaces. Filtration occurs as runoff passes through the biocell media, such as the plant cover and planting soil which aids in dropping out particulates, sediment and pollutants adsorbed onto sediment (including, for example certain pesticides and pathogens). Pollutants removed by adsorption include metals, phosphorus, and hydrocarbons.

The following properties of landscaping biocells within the streets were used to calculate the water quality treatment potential for these features:

- 8-inch gravel base above the sub-grade with perforated drainage pipes
- 24 inch of amended soil with filter fabric to separate from the gravel base
- 2-4 inch of mulch
- 6 inch ponding depth where the bottom occurs at the top of the mulch and the top occurs at the spillover elevation where water will bypass the biocell and drain towards the nearest catch basin inlet when at full capacity.

Drainage from the roadways and adjacent lot drainage may be directed to the parkway bioswales with the landscaping biocell features via sheet flow, curb cuts and shallow first-flush collection pipes for

³ US Environmental Protection Agency (US EPA). Storm Water Phase II Proposed Rule Fact Sheet Series, Fact Sheet 3.0. April 1999.

water quality treatment. In some instances, a surface slope (longitudinally) may be required within the biocell. In these instances, the slope and ponding depth will be accounted for in the treatment volume calculation.

The profile and depths of the biocell will vary in the final design, and all changes will be accounted for in the treatment volume calculations. In most instances, it will not be necessary to construct the biocell sub-surface design feature into all portions of the parkway bioswale locations. Based on the upstream tributary areas and the treatment capacity of the biocells, only a portion of the parkway bioswale will need to include the biocell sub-surface design feature to meet the volume treatment requirements of the upstream road runoff. In the event it is feasible to direct surface runoff from the lots in addition to the road runoff into the parkway bioswales, the size of biocell component will be increased accordingly.

Bioretention Cells with Underdrains

The proposed project will incorporate water quality bioretention cells to provide the backbone treatment system for the majority of the project site.

Bioretention cells (also known as rain gardens or biocells) are vegetated basins that promote filtration of storm water runoff. They combine shrubs, grasses, and flowering perennials in depressions (approximately 6 to 8 inches deep) that allow water to pool, infiltrate, evaporate and/or slowly drain out within 48 to 72 hours. Similar to the landscaped biocells, bioretention cells function as a soil and plant-based filtration devices that removes pollutants through a variety of physical, biological, and chemical treatment processes. The major treatment of runoff occurs through the percolation of runoff through several layers prior to either infiltrating into the ground (if feasible) or collected by sub-drains and returned back to the storm drain system. Pollutants are removed through processes such as adsorption, filtration, plant uptake, microbial activity, decomposition, sedimentation and volatilization.

Consistent with the Model WQMP TGD, the following properties of the bioretention cells were used to calculate the water quality treatment potential:

- 8-inch gravel base above the sub-grade with perforated drainage pipes
- 24 inch of amended soil with filter fabric to separate from the gravel base
- 2-4 inch of mulch
- 18 inch maximum ponding depth, where the bottom occurs at the top of the mulch and the top occurs at the spillover elevation where water will bypass into the storm drain system.

For those located along the fringes of the development adjacent to the coastal bluff-tops and where infiltration is infeasible, the entire system must be lined with sub-drains to reduce infiltration into the soils and provide long-term integrity of the soils.

Drainage from the adjacent development areas may be directed to the bioretention cells via curb cuts, low-flow diversions from the storm drain system or use of shallow first-flush collection pipes for water quality treatment. Detailed drainage calculations, grading, and confirmation of sizing will occur during the detailed design phase and subsequent Final WQMP documentation.

Preliminary Design Calculations

In accordance with the MS4 permit and the new Model WQMP, the proposed LID BMPs were evaluated to determine the appropriate footprints and depths required to treat the required Design Capture Volumes (DCVs) for each of the on-site drainage areas identified in Section IV.2.2. Where both landscaped biocells and bioretention cells are proposed within the same larger drainage area, the bioretention cell was assumed to serve as primary treatment and does not exclude the biocell's tributary drainage area. Footprints for the bioretention cells and landscaped biocells were determined in accordance with BMP Fact Sheet BIO-1 included in Appendix XIV of the TGD. Final design and calculations will be identified and documented during project Final WQMP development. General locations and the footprints of the evaluated BMPs are illustrated in the *Preliminary Water Quality Management Plan Exhibit*, included in Section VI. Detailed calculations are provided in Appendix A.

PRELIMINARY DESIGN CALCULATIONS SUMMARY FOR LID BMPs									
Drainage Area ID	Land Use Type	Drainage Area (ac)	DCV (ft ³)	Bioretention With Underdrains (Biotreatment)			Landscaped Biocells (Bioretention w/ Underdrains)		
				Ponding Depth (ft)	Depth Filtered (ft)	Footprint Needed (ft ²)	Ponding Depth (ft)	Depth Filtered (ft)	Footprint Needed (ft ²)
WCH Tributary - Storm Drain A									
A19.4	Community Park	3.90	2,616	1.5	0.625	1,231.2	--	--	--
A19.2	Community Park	6.81	4,568	1.5	0.625	2,149.8	--	--	--
A7.3	Community Park	4.18	2,804	1.5	0.625	1,319.6	--	--	--
South Arroyo Tributary - Southerly Drainage Areas (Storm Drain B)									
TOTAL	--	33.47	56,412	1.5	0.625	26,546.8	--	--	--
South Arroyo Tributary - Northerly Drainage Areas (Storm Drain C)									
TOTAL	--	22.94	37,417	1.5	0.625	17,608.1	--	--	--
Lowlands Tributary - West of "B" Street (Storm Drain D)									
TOTAL ⁽¹⁾	--	55.43	91,356	1.5	0.625	42,990.9	--	--	--
Lowlands Tributary - East of "B" Street (Storm Drain E)									
C12.2	Mixed Use/Residential	5.11	9,758	1.5	0.625	4,591.9	--	--	--
Lowlands Tributary - Storm Drain F									
B11.1	Mixed Use/Residential	4.57	8,727	1.5	0.625	4,106.7	--	--	--
Arterial Streets w/ Landscaped Biocells (stand alone - not included in drainage areas above)									
A19.1	Arterial Road	1.09	2,289	--	--	--	0.50	0.50	2,289.1
A19.3	Arterial Road	1.58	3,318	--	--	--	0.50	0.50	3,318.2
A19.5	Arterial Road	2.93	6,153	--	--	--	0.50	0.50	6,153.4
A19.7	Arterial Road	2.52	5,292	--	--	--	0.50	0.50	5,292.3

PRELIMINARY DESIGN CALCULATIONS SUMMARY FOR LID BMPs									
Drainage Area ID	Land Use Type	Drainage Area (ac)	DCV (ft ³)	Bioretention With Underdrains (Biotreatment)			Landscaped Biocells (Bioretention w/ Underdrains)		
				Ponding Depth (ft)	Depth Filtered (ft)	Footprint Needed (ft ²)	Ponding Depth (ft)	Depth Filtered (ft)	Footprint Needed (ft ²)
A7.5	Arterial Road	1.9	3,990	--	--	--	0.50	0.50	3,990.3
B11.3	Arterial Road	2.21	4,641	--	--	--	0.50	0.50	4,641.3
D3.2	Arterial Road	2.72	5,712	--	--	--	0.50	0.50	5,712.4

Notes:
 1. Includes 1.94 acres of upstream, off-site tributary area.

Planning-Level Water Quality Modeling

To analyze the effectiveness of the proposed bioretention features and the extended detention basin for off-site runoff (discussed further in Section IV.3.7), water quality modeling was conducted to predict anticipated changes in storm water runoff quality and quantity for proposed versus existing conditions (see Appendix G). The model does not take into account hydrologic source controls, storm drain routing, Time of Concentration, pipe storage or other drainage design features that would reduce the predicted storm water volumes.

The results of the planning-level water quality modeling demonstrate the following: (i) a calculated increase in storm water runoff volume, (ii) limited calculated overall changes in pollutant loads (existing versus post-development condition), and (iii) improved calculated water quality (i.e., reduced concentrations) in the post-development condition given the change in land uses and implementation and maintenance of project design features (PDF). A summary of the predicted calculated average annual pollutant concentrations are provided below. See additional details in Appendix G.

PREDICTED CALCULATED AVERAGE ANNUAL POLLUTANT CONCENTRATIONS, ON-SITE PLUS OFF-SITE					
Parameter	Units	Existing Conditions	Developed Conditions w/o PDFs	Developed Conditions w/ PDFs	Change
TSS	mg/L	171	117	72	-99
Total Phosphorous	mg/L	0.3	0.3	0.2	-0.1
Dissolved Phosphorus	mg/L	0.18	0.26	0.15	-0.03
Nitrate-N	mg/L	1.0	0.9	0.6	-0.4
Ammonia-N	mg/L	0.5	0.6	0.3	-0.2
Total Kjeldahl Nitrogen	mg/L	2.0	2.3	1.6	-0.4
Dissolved Copper	µg/L	6.1	10.1	5.9	-0.2
Total Copper	µg/L	20	23	12	-8
Total Lead	µg/L	8	8	5	-3

PREDICTED CALCULATED AVERAGE ANNUAL POLLUTANT CONCENTRATIONS, ON-SITE PLUS OFF-SITE					
Parameter	Units	Existing Conditions	Developed Conditions w/o PDFs	Developed Conditions w/ PDFs	Change
Dissolved Zinc	µg/L	111	100	60	-51
Total Zinc	µg/L	150	149	69	-81

Note: Model results are rounded per the following convention: results are rounded to a uniform level of precision for each parameter such that at least one significant figure is reported for each value, or such that numbers are rounded to the nearest integer, whichever results in greater precision. The number of reported significant figures is intended to prevent introduction of rounding errors; it is not intended to imply model prediction certainty.

IV.3.5 Hydromodification Control BMPs

Not applicable. LID BMPs utilizing biofiltration will be utilized for water quality treatment on-site in accordance with the MS4 Permit hierarchy identified at the beginning of this Section.

IV.3.6 Regional/Sub-Regional LID BMPs

Not applicable. LID BMPs utilizing biofiltration will be utilized for water quality treatment on-site in accordance with the MS4 Permit hierarchy identified at the beginning of this Section.

IV.3.7 Treatment Control BMPs

Treatment control BMPs can only be considered if the project conformance analysis indicates that it is not feasible to retain the full design capture volume with LID BMPs.

TREATMENT CONTROL BMPs		
ID	Name	Included?
TRT-1	Sand Filters	<input type="checkbox"/>
TRT-2	Cartridge Media Filter	<input type="checkbox"/>
PRE-1	Hydrodynamic Separation Device	<input type="checkbox"/>
PRE-2	Catch Basin Insert	<input type="checkbox"/>
TC-22	Other: Extended Detention Basin	<input checked="" type="checkbox"/>

For on-site development areas, LID BMPs will be utilized in lieu of treatment control BMPs for water quality treatment on-site in accordance with the MS4 Permit hierarchy identified at the beginning of this Section.

Although not a requirement of the Project, the Project proposes a water quality basin located near 16th Street to treat 48 acres of off-site Costa Mesa runoff that flows onto the project site that does not co-

mingle with project flows. The regional facility will be designed to accommodate approximately 2.3-acre-feet of water quality treatment, which will accommodate all urban runoff (dry weather) and the majority of the 85th percentile storm event. Due to sizing limitations and other physical constraints, it is not feasible to design this basin to treat the entire 85th percentile 24-hour storm event nor is it a requirement of the Project. The basin would be designed to treat as much as can be physically accommodated at this location and provide a reduction in peak flows to reduce scour potential within the Southern Arroyo.

Extended detention basins are basins whose outlets have been designed to detain storm water runoff for some minimum time (e.g., 48-72 hours) to allow particles and associated pollutants to settle. They do not have a permanent pool and are designed to drain completely between storm events. The slopes and bottom of the basins are typically vegetated, and can also be used to provide additional flood control benefits by modifying the outlet structure and providing additional storage.

The proposed extended detention basin for off-site flows has a bottom footprint of approximately 21,164 ft² and a max ponding depth of 5 ft, for an approximate capacity of 2.3 acre-feet.

IV.3.8 Non-Structural Source Control BMPs

The table below indicates all BMPs to be incorporated in the project. For those designated as not applicable (N/A), a brief explanation why is provided.

NON-STRUCTURAL SOURCE CONTROL BMPs				
ID	Name	Included?	Not Applicable?	If Not Applicable, Provide Brief Reason
N1	Education for Property Owners, Tenants and Occupants	<input checked="" type="checkbox"/>	<input type="checkbox"/>	
N2	Activity Restrictions	<input checked="" type="checkbox"/>	<input type="checkbox"/>	
N3	Common Area Landscape Management	<input checked="" type="checkbox"/>	<input type="checkbox"/>	
N4	BMP Maintenance	<input checked="" type="checkbox"/>	<input type="checkbox"/>	
N5	Title 22 CCR Compliance (How development will comply)	<input type="checkbox"/>	<input checked="" type="checkbox"/>	Not applicable. No industrial land uses proposed.
N6	Local Industrial Permit Compliance	<input type="checkbox"/>	<input checked="" type="checkbox"/>	The City of Newport Beach does not issue water quality permits.
N7	Spill Contingency Plan	<input type="checkbox"/>	<input checked="" type="checkbox"/>	Not applicable. No industrial land uses proposed.
N8	Underground Storage Tank Compliance	<input type="checkbox"/>	<input checked="" type="checkbox"/>	Not applicable. No industrial land uses proposed.
N9	Hazardous Materials Disclosure Compliance	<input type="checkbox"/>	<input checked="" type="checkbox"/>	Not applicable. No industrial land uses proposed.
N10	Uniform Fire Code Implementation	<input type="checkbox"/>	<input checked="" type="checkbox"/>	Not applicable. No industrial land uses proposed.

NON-STRUCTURAL SOURCE CONTROL BMPs				
ID	Name	Included?	Not Applicable?	If Not Applicable, Provide Brief Reason
N11	Common Area Litter Control	<input checked="" type="checkbox"/>	<input type="checkbox"/>	
N12	Employee Training	<input checked="" type="checkbox"/>	<input type="checkbox"/>	
N13	Housekeeping of Loading Docks	<input checked="" type="checkbox"/>	<input type="checkbox"/>	
N14	Common Area Catch Basin Inspection	<input checked="" type="checkbox"/>	<input type="checkbox"/>	
N15	Street Sweeping Private Streets and Parking Lots	<input checked="" type="checkbox"/>	<input type="checkbox"/>	
N16	Retail Gasoline Outlets	<input type="checkbox"/>	<input checked="" type="checkbox"/>	No retail gasoline outlets are proposed as part of the project.

N1, Education for Property Owners, Tenants and Occupants

Educational materials will be provided to residents/tenants, including education materials and restrictions to reduce pollutants from reaching the storm drain system. Examples include tips for pet care, proper waste oil disposal, and other household tips. Tenants will be provided storm water pollution prevention materials by the Property Management prior to occupancy. Materials will be provided periodically thereafter. Refer to Section VII for a list of educational materials to be provided.

N2, Activity Restrictions

The HOA shall restrict activities that have the potential to create adverse impacts on water quality. Activities include but are not limited to: prohibiting vehicle maintenance activities within parking areas and stalls, prohibiting long-term parking without prior authorization, and prohibiting outdoor vehicle washing. Restriction shall begin upon occupancy.

N3, Common Area Landscape Management

Common area landscape management that includes minimizing fertilizer and pesticide application, use of slow-release fertilizers, maintenance activities, providing education to homeowners and tenants (via project owner and/or HOA), and providing education and training for employees on management of landscape materials and storm water management. Maintenance shall be conducted on a monthly basis at a minimum, and management measures shall be implemented upon completion of landscaping for the project.

N4, BMP Maintenance

The HOA will be responsible for the implementation and maintenance of each applicable non-structural BMP, as well as scheduling inspections and maintenance of all applicable structural BMP facilities through its staff, landscape contractor, and/or any other necessary maintenance contractors. Details on BMP Maintenance are provided in Section V of this P-WQMP.

N11, Common Area Litter Control

The HOA will be responsible for performing trash pickup and sweeping of littered common areas as needed and weekly at a minimum. Any trash/debris waste collected shall be properly disposed of in accordance with local regulations. Responsibilities will also include noting improper disposal of materials by the public and reporting such violations for further investigation.

N12, Employee Training

All employees of the HOA and any contractors will require training to ensure that employees are aware of maintenance activities that may result in pollutants reaching the storm drain. Training will include, but not be limited to, spill cleanup procedures, proper waste disposal, housekeeping practices, etc.

N13, Housekeeping of Loading Docks

No below-grade loading docks are proposed. Housekeeping measures will be implemented to keep any delivery areas clean and orderly condition. These measures include but are not limited to sweeping, removal of trash & debris on a weekly basis, and use of dry methods for cleanup.

N14, Common Area Catch Basin Inspection

All on-site storm drain inlets, curb and gutters and ribbon gutter systems shall be inspected and cleaned out by the HOA at least once a year, prior to the rainy season, no later than October 1st of each year. All public drainage facilities will be maintained by the City of Newport Beach.

N15, Street Sweeping Private Streets and Parking Lots

The HOA shall be responsible for the street sweeping of all private street, drive aisles and parking areas within the project quarterly, and prior to the rainy season, no later than October 1st each year. The City of Newport Beach shall be responsible for sweeping of public streets.

IV.3.9 Structural Source Control BMPs

The table below indicates all BMPs to be incorporated in the project. For those designated as not applicable (N/A), a brief explanation why is provided.

STRUCTURAL SOURCE CONTROL BMPs				
ID	Name	Included?	Not Applicable?	If Not Applicable, Provide Brief Reason
S1 SD-13	Provide storm drain system stenciling and signage	<input checked="" type="checkbox"/>	<input type="checkbox"/>	
S2 SD-34	Design and construct outdoor material storage areas to reduce pollution introduction	<input type="checkbox"/>	<input checked="" type="checkbox"/>	No outdoor material storage areas are proposed as part of the project.
S3 SD-32	Design and construct trash and waste storage areas to reduce pollution introduction	<input checked="" type="checkbox"/>	<input type="checkbox"/>	

STRUCTURAL SOURCE CONTROL BMPs				
ID	Name	Included?	Not Applicable?	If Not Applicable, Provide Brief Reason
S4 SD-12	Use efficient irrigation systems & landscape design, water conservation, smart controllers, and source control	<input checked="" type="checkbox"/>	<input type="checkbox"/>	
S5	Protect slopes and channels and provide energy dissipation	<input checked="" type="checkbox"/>	<input type="checkbox"/>	
S6 SD-31	Properly Design: Dock areas	<input type="checkbox"/>	<input checked="" type="checkbox"/>	No below-grade loading docks are proposed.
S7 SD-31	Properly Design: Maintenance bays	<input type="checkbox"/>	<input checked="" type="checkbox"/>	No maintenance bays are proposed.
S8 SD-33	Properly Design: Vehicle wash areas	<input type="checkbox"/>	<input checked="" type="checkbox"/>	No vehicle wash areas are proposed.
S9 SD-36	Properly Design: Outdoor processing areas	<input type="checkbox"/>	<input checked="" type="checkbox"/>	No outdoor processing areas are proposed.
S10	Properly Design: Equipment wash areas	<input type="checkbox"/>	<input checked="" type="checkbox"/>	No equipment wash areas are proposed.
S11 SD-30	Properly Design: Fueling areas	<input type="checkbox"/>	<input type="checkbox"/>	No fueling areas are proposed.
S12 SD-10	Properly Design: Hillside landscaping	<input type="checkbox"/>	<input checked="" type="checkbox"/>	Project is not located in a hillside area. Slopes will be protected in accordance with BMP S5.
S13	Properly Design: Wash water control for food preparation areas	<input checked="" type="checkbox"/>	<input type="checkbox"/>	
S14	Properly Design: Community car wash racks	<input type="checkbox"/>	<input checked="" type="checkbox"/>	No community car wash racks are proposed as part of the project.

S1/SD-13, Provide storm drain system stenciling and signage

The phrase “NO DUMPING! DRAINS TO OCEAN” or an equally effective phrase approved by the City, will be stenciled on all major storm drain inlets within the project site to alert the public to the destination of pollutants discharged into storm water. Stencils shall be in place by completion of construction.

S3/SD-32, Design and construct trash and waste storage areas to reduce pollution introduction

All trash and waste shall be stored in containers that have lids or tarps to minimize direct precipitation into the containers. Any trash storage areas will be paved, covered, and either be sloped to landscaping areas or include a barrier to keep drainage out of the storm drain. The HOA shall ensure trash is stored properly and does not come into contact with storm water runoff.

S4/SD-12, Use efficient irrigation systems & landscape design, water conservation, smart controllers, and source control

Irrigation systems would be designed to meet City standards for water efficient landscaping, as applicable in accordance with Newport Beach Municipal Code Chapter 14.17 and Chapter 5 (Master Landscape Plan) of the Master Development Plan. Where feasible, includes incorporation of native tolerant species for landscaping, protection of slopes and efficient irrigation. May be used in conjunction with educational materials to homeowners/tenants as well as activity restrictions. Maintenance of the irrigation systems shall be conducted monthly at a minimum, and shall be implemented upon completion of landscaping for the project.

S5, Protect slopes and channels and provide energy dissipation

All disturbed slopes will be re-vegetated and stabilized to prevent erosion. A diffuser basin will be located downstream of the Southern Arroyo and Storm Drains B and C to provide channel stability, dissipate erosive energy before flows enter the Semeniuk Slough, and control sediment contributions to the Semeniuk Slough. A diffuser basin will also be installed downstream of Storm Drains D and Storm Drain E to reduce the momentum of the flows from the pipes and to spread the distribution of runoff to the Lowland in a manner that will enable future habitat restoration efforts.

S13, Properly Design: Wash water control for food preparation areas

All wash water from food preparation areas will be conveyed to the site's sewer system. Food preparation facilities shall meet all health and safety, building and safety and any other applicable regulations, codes requirements. Grease interceptors will be located in the sewer lines were applicable.

IV.4 ALTERNATIVE COMPLIANCE PLAN

IV.4.1 Water Quality Credits

Local jurisdictions may develop a water quality credit program that applies to certain types of development projects after they first evaluate the feasibility of meeting LID requirements on-site. If it is not feasible to meet the requirements for on-site LID, project proponents for specific project types can apply credits that would reduce project obligations for selecting and sizing other treatment BMPs or participating in other alternative programs.

WATER QUALITY CREDITS	
Credit	Applicable?
Redevelopment projects that reduce the overall impervious footprint of the project site.	<input type="checkbox"/>
Brownfield redevelopment, meaning redevelopment, expansion, or reuse of real property which may be complicated by the presence or potential presence of hazardous substances, pollutants or contaminants, and which have the potential to contribute to adverse ground or surface water quality if not redeveloped.	<input type="checkbox"/>

WATER QUALITY CREDITS	
Credit	Applicable?
Higher density development projects which include two distinct categories (credits can only be taken for one category): those with more than seven units per acre of development (lower credit allowance); vertical density developments, for example, those with a Floor to Area Ratio (FAR) of 2 or those having more than 18 units per acre (greater credit allowance)	<input type="checkbox"/>
Mixed use development, such as a combination of residential, commercial, industrial, office, institutional, or other land uses which incorporate design principles that can demonstrate environmental benefits that would not be realized through single use projects (e.g. reduced vehicle trip traffic with the potential to reduce sources of water or air pollution).	<input type="checkbox"/>
Transit-oriented developments, such as a mixed use residential or commercial area designed to maximize access to public transportation; similar to above criterion, but where the development center is within one half mile of a mass transit center (e.g. bus, rail, light rail or commuter train station). Such projects would not be able to take credit for both categories, but may have greater credit assigned	<input type="checkbox"/>
Redevelopment projects in an established historic district, historic preservation area, or similar significant city area including core City Center areas (to be defined through mapping).	<input type="checkbox"/>
Developments with dedication of undeveloped portions to parks, preservation areas and other pervious uses.	<input type="checkbox"/>
Developments in a city center area.	<input type="checkbox"/>
Developments in historic districts or historic preservation areas.	<input type="checkbox"/>
Live-work developments, a variety of developments designed to support residential and vocational needs together – similar to criteria to mixed use development; would not be able to take credit for both categories.	<input type="checkbox"/>
In-fill projects, the conversion of empty lots and other underused spaces into more beneficially used spaces, such as residential or commercial areas.	<input type="checkbox"/>

At this time, however, no water quality credits have been applied to the project’s DCV. Should any applicable credits be applied in the future, they shall be documented in the Final WQMP.

IV.4.2 Alternative Compliance Plan Information

Not applicable. LID BMPs will be utilized for water quality treatment on-site in accordance with the MS4 Permit hierarchy identified at the beginning of this Section.

SECTION V INSPECTION/MAINTENANCE RESPONSIBILITY FOR BMPs

It has been determined that the Owner, via HOA shall assume all BMP inspection and maintenance responsibilities for the Newport Banning Ranch project.

Contact Name:	Pending – to be provided in the Final WQMP
Title:	
Company:	
Address:	
Phone:	
Fax:	
Email:	

Should the maintenance responsibility be transferred at any time during the operational life of Newport Banning Ranch, such as when an HOA or POA is formed for a project, a formal notice of transfer shall be submitted to the City of Newport Beach at the time responsibility of the property subject to this WQMP is transferred. The transfer of responsibility shall be incorporated into this WQMP as an amendment.

The HOA shall verify BMP implementation and ongoing maintenance through inspection, self-certification, survey, or other equally effective measure. The certification shall verify that, at a minimum, the inspection and maintenance of all structural BMPs including inspection and performance of any required maintenance in the late summer / early fall, prior to the start of the rainy season. A form that may be used to record implementation, maintenance, and inspection of BMPs is included in Appendix D.

The City of Newport Beach may conduct verifications to assure that implementation and appropriate maintenance of structural and non-structural BMPs prescribed within this WQMP is taking place at the project site. The HOA shall retain operations, inspections and maintenance records of these BMPs and they will be made available to the City or County upon request. All records must be maintained for at least five (5) years after the recorded inspection date for the lifetime of the project.

Long-term funding for BMP maintenance shall be funded through fees paid into the HOA. Newport Banning Ranch, LLC, which will set up the HOA shall oversee that adequate funding for BMP maintenance is included within the HOA fee structure including annual maintenance fees and long-term maintenance reserve funds.

BMP INSPECTION & MAINTENANCE RESPONSIBILITY MATRIX				
	BMP	Inspection/Maintenance Activities	Minimum Frequency	Responsible Party
BIOTREATMENT BMPs				
BIO-1	Landscaped Biocells	Inspections should occur semi-annually or after major storm events to check for the following and remove accordingly: standing water, sediment, and trash & debris. Inspections should also look for potential clogging and clean planters or, if necessary, replace the entire filter bed. Inspect for weeds, and prune and/or replace plants in accordance with routine landscape maintenance activities. Replace mulch as necessary. Conduct routine mowing of grass in swale to maintain appropriate grass height.	2x per year	Private Areas: HOA Public Areas: City of Newport Beach
BIO-1	Bioretention Cells	Inspections should occur semi-annually or after major storm events to check for the following and remove accordingly: standing water, sediment, and trash & debris. Inspections should also look for potential clogging and clean planters or, if necessary, replace the entire filter bed. Inspect for weeds, and prune and/or replace plants in accordance with routine landscape maintenance activities. Replace mulch and prune shrubs as necessary.	2x per year	Private Areas: HOA Public Areas: City of Newport Beach
TREATMENT CONTROL BMPs				

BMP INSPECTION & MAINTENANCE RESPONSIBILITY MATRIX				
	BMP	Inspection/Maintenance Activities	Minimum Frequency	Responsible Party
--	Extended Detention Basin (for off-site flows)	Inspections should occur for standing water, slope stability, sediment accumulation, trash & debris, and presence of burrows at the beginning and end of wet season at a minimum. Routine maintenance includes trash and debris removal in the basin and around the riser pipe. Inspect for weeds, and prune and/or replace plants in accordance with routine landscape maintenance activities. Remove accumulated sediment when volume exceeds 10% of the basin volume, typically every 10 years.	2x per year	HOA
NON-STRUCTURAL SOURCE CONTROL BMPs				
N1	Education for Property Owners, Tenants and Occupants	Educational materials will be provided to tenants annually. Materials to be distributed are found in Appendix C of this WQMP. Tenants will be provided these materials by the Property Management prior to occupancy and annually thereafter.	Annually	HOA
N2	Activity Restrictions	The Owner will prescribe activity restrictions to protect surface water quality, through lease terms or other equally effective measure, for the property. Restrictions include, but are not limited to, prohibiting vehicle maintenance or vehicle washing.	Ongoing	HOA

BMP INSPECTION & MAINTENANCE RESPONSIBILITY MATRIX				
	BMP	Inspection/Maintenance Activities	Minimum Frequency	Responsible Party
N3	Common Area Landscape Management	Maintenance shall be consistent with City requirements. Fertilizer and/or pesticide usage shall be consistent with County Management Guidelines for Use of Fertilizers (OC DAMP Section 5.5) as well as City requirements. Maintenance includes mowing, weeding, and debris removal on a weekly basis. Trimming, replanting, and replacement of mulch shall be performed on an as-needed basis to prevent exposure of erodible surfaces. Trimmings, clippings, and other landscape wastes shall be properly disposed of in accordance with local regulations. Materials temporarily stockpiled during maintenance activities shall be placed away from water courses and storm drains inlets.	Monthly	Private Areas: HOA Public Areas: City of Newport Beach
N4	BMP Maintenance	Maintenance of structural BMPs implemented at the project site shall be performed at the frequency prescribed in this WQMP. Records of inspections and BMP maintenance shall be kept by the Owner and shall be available for review upon request.	Ongoing	Private Areas: HOA Public Areas: City of Newport Beach
N5	Title 22 CCR Compliance (How development will comply)	Not applicable.		
N6	Local Industrial Permit Compliance	Not applicable.		
N7	Spill Contingency Plan	Not applicable.		

BMP INSPECTION & MAINTENANCE RESPONSIBILITY MATRIX				
	BMP	Inspection/Maintenance Activities	Minimum Frequency	Responsible Party
N8	Underground Storage Tank Compliance	Not applicable.		
N9	Hazardous Materials Disclosure Compliance	Not applicable.		
N10	Uniform Fire Code Implementation	Not applicable.		
N11	Common Area Litter Control	Litter patrol, violations investigations, reporting and other litter control activities shall be performed on a weekly basis and in conjunction with routine maintenance activities.	Weekly	Private Areas: HOA Public Areas: City of Newport Beach
N12	Employee Training	Educate all new employees/ managers on storm water pollution prevention, particularly good housekeeping practices, prior to the start of the rainy season (October 1). Refresher courses shall be conducted on an as needed basis.	Annually	HOA
N13	Housekeeping of Loading Docks	Sweep delivery areas weekly and remove any trash/debris. Keep area clean of trash and debris at all times. Spills shall be cleaned up immediately using dry methods.	Weekly	HOA
N14	Common Area Catch Basin Inspection	Catch basin inlets and other drainage facilities shall be inspected after each storm event and once per year. Inlets and other facilities shall be cleaned prior to the rainy season, by October 1 st each year.	Annually	Private Areas: HOA Public Areas: City of Newport Beach

BMP INSPECTION & MAINTENANCE RESPONSIBILITY MATRIX				
	BMP	Inspection/Maintenance Activities	Minimum Frequency	Responsible Party
N15	Street Sweeping Private Streets and Parking Lots	Streets & parking lots must be swept at least quarterly (every 3 months), including prior to the start of the rainy season (October 1 st).	Quarterly	Private Areas: HOA Public Areas: City of Newport Beach
N16	Retail Gasoline Outlets	Not applicable.		
STRUCTURAL SOURCE CONTROL BMPs				
S1 SD-13	Provide storm drain system stenciling and signage	Storm drain stencils shall be inspected for legibility, at minimum, once prior to the storm season, no later than October 1 st each year. Those determined to be illegible will be re-stenciled as soon as possible.	Annually	Private Areas: HOA Public Areas: City of Newport Beach
S2 SD-34	Design and construct outdoor material storage areas to reduce pollution introduction	Not applicable.		
S3 SD-32	Design and construct trash and waste storage areas to reduce pollution introduction	Sweep trash area at least once per week and before October 1 st each year. Maintain area clean of trash and debris at all times.	Weekly	HOA
S4 SD-12	Use efficient irrigation systems & landscape design, water conservation, smart controllers, and source control	In conjunction with routine maintenance activities, verify that landscape design continues to function properly by adjusting properly to eliminate overspray to hardscape areas, and to verify that irrigation timing and cycle lengths are adjusted in accordance with water demands, given time of year, weather, and day or night time temperatures.	Monthly	Private Areas: HOA Public Areas: City of Newport Beach

BMP INSPECTION & MAINTENANCE RESPONSIBILITY MATRIX				
	BMP	Inspection/Maintenance Activities	Minimum Frequency	Responsible Party
S5	Protect slopes and channels and provide energy dissipation	To be performed in conjunction with maintenance activities. Maintain vegetative cover and/or mulch to eliminate exposed soils. Any eroded surfaces to be repaired immediately. Inspections to be performed twice each year (spring and fall) and after major storm events to check for signs of erosion, gullies, and sloughing.	Monthly	HOA
S6 SD-31	Properly Design: Dock areas	Not applicable.		
S7 SD-31	Properly Design: Maintenance bays	Not applicable.		
S8 SD-33	Properly Design: Vehicle wash areas	Not applicable.		
S9 SD-36	Properly Design: Outdoor processing areas	Not applicable.		
S10	Properly Design: Equipment wash areas	Not applicable.		
S11 SD-30	Properly Design: Fueling areas	Not applicable.		
S12 SD-10	Properly Design: Hillside landscaping	Not applicable.		
S13	Properly Design: Wash water control for food preparation areas	Food preparation areas will be inspected on a regular basis to ensure proper waste disposal and water usage procedures. Any grease interceptors shall be inspected and maintained in accordance with manufacturer's recommendations (typically quarterly).	Quarterly	HOA / Resort Operator
S14	Properly Design: Community car wash racks	Not applicable.		

Any waste generated from maintenance activities will be disposed of properly. Wash water and other waste from maintenance activities is not to be discharged or disposed of into the storm drain system. Clippings from landscape maintenance (i.e. prunings) will be collected and disposed of properly off-site, and will not be washed into the streets, local area drains/conveyances, or catch basin inlets.

SECTION VI SITE PLAN AND DRAINAGE PLAN

The exhibits provided in this section are to illustrate the post construction BMPs prescribed within this WQMP. Drainage flow information of the proposed project, such as general surface flow lines, concrete or other surface drainage conveyances, and storm drain facilities are also depicted. All structural source control and treatment control BMPs are shown as well.

EXHIBITS

- Vicinity Map
- Site Plan
- Preliminary WQMP Exhibit
- Typical Cross Sections

BMP DETAILS

- BIO-1 Bioretention With Underdrains
- TC-22 Extended Detention Basin

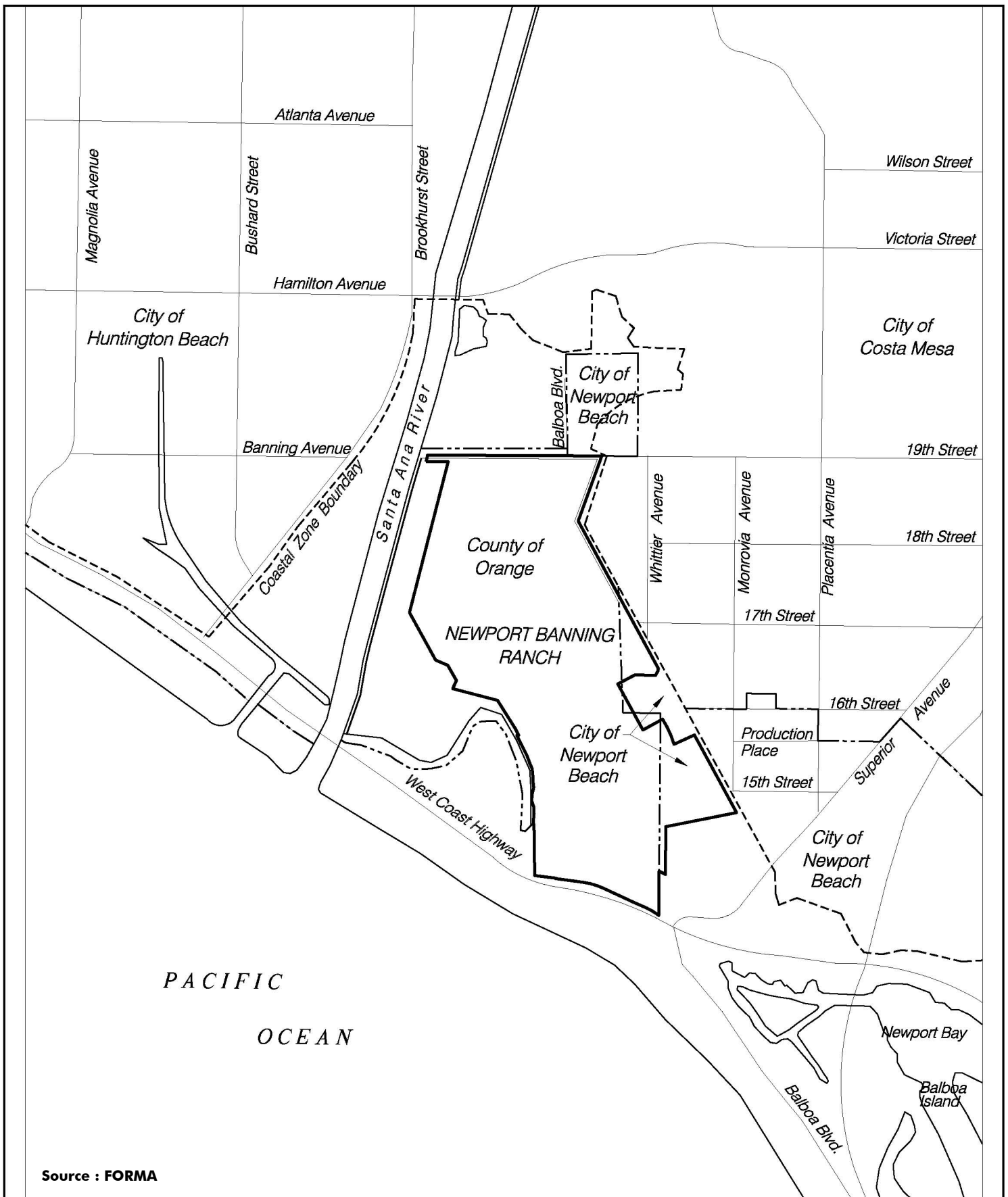

P:\Projects\821\01\Wat\GISwat\MXD\EIR Figures&Exhibits\82101gh-Fig1_Vicinity_Map.pdf

NEWPORT BANNING RANCH

FIGURE 1: Project Vicinity Map

April 9, 2010



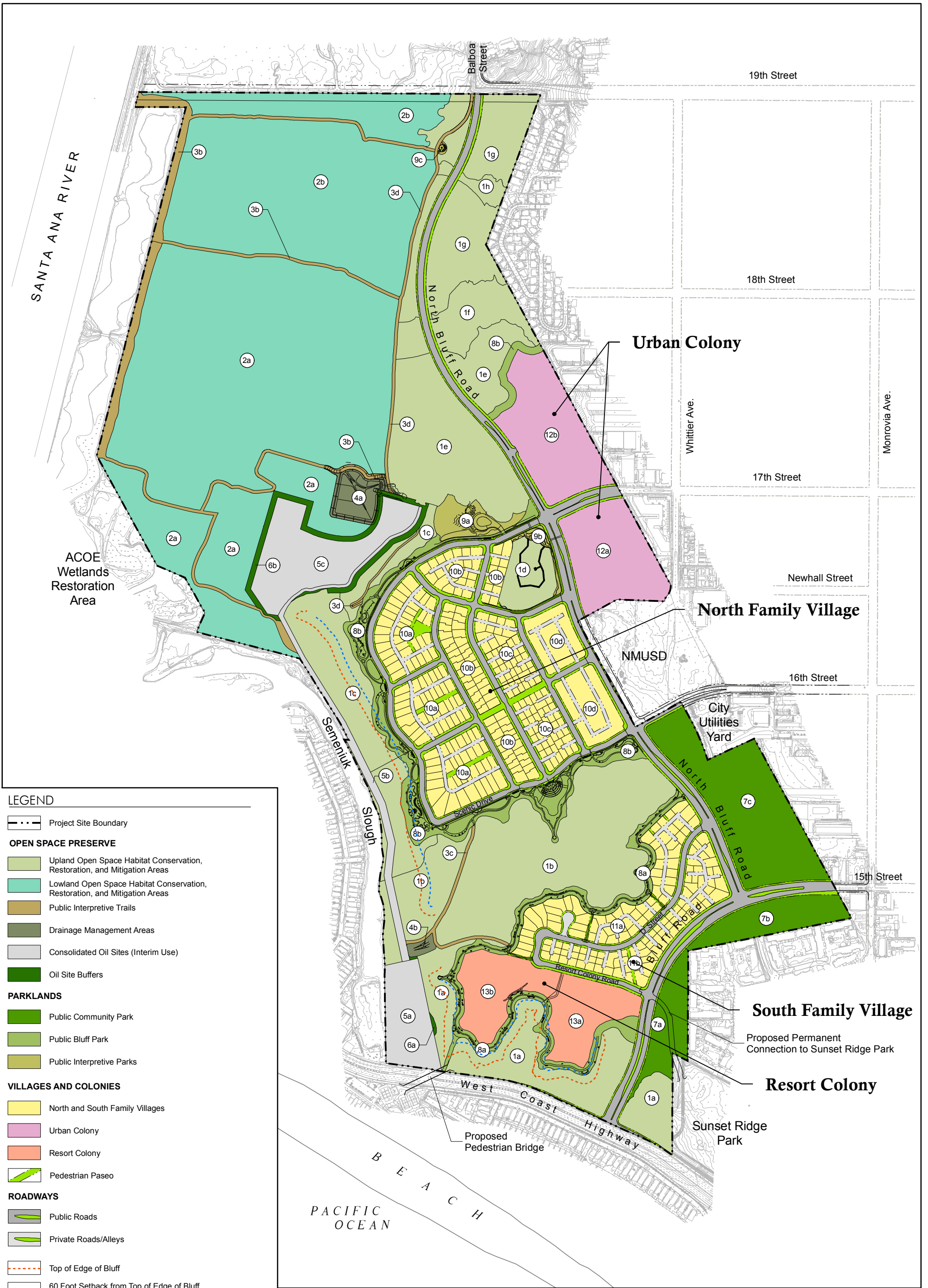

F:\PROJECTS\B21\01\WQMP\B2101\WQMP-120203.DWG (02-03-12 3:52:13PM) Plotted by: April McMillan

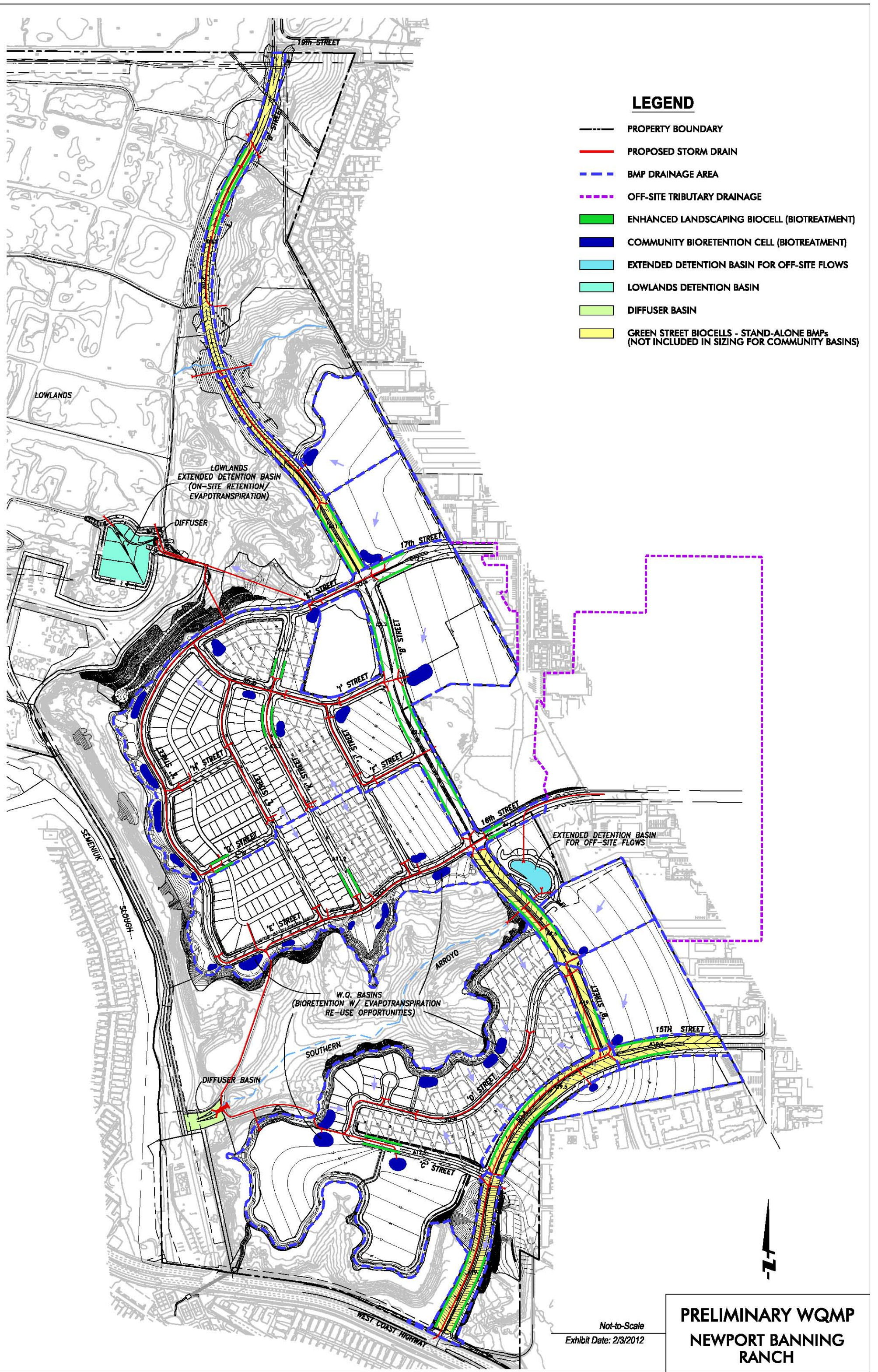

LEGEND

- PROPERTY BOUNDARY
- PROPOSED STORM DRAIN
- BMP DRAINAGE AREA
- OFF-SITE TRIBUTARY DRAINAGE
- ENHANCED LANDSCAPING BIOCELL (BIOTREATMENT)
- COMMUNITY BIORETENTION CELL (BIOTREATMENT)
- EXTENDED DETENTION BASIN FOR OFF-SITE FLOWS
- LOWLANDS DETENTION BASIN
- DIFFUSER BASIN
- GREEN STREET BIOCELLS - STAND-ALONE BMPs (NOT INCLUDED IN SIZING FOR COMMUNITY BASINS)

Not-to-Scale
Exhibit Date: 2/3/2012

PRELIMINARY WQMP NEWPORT BANNING RANCH

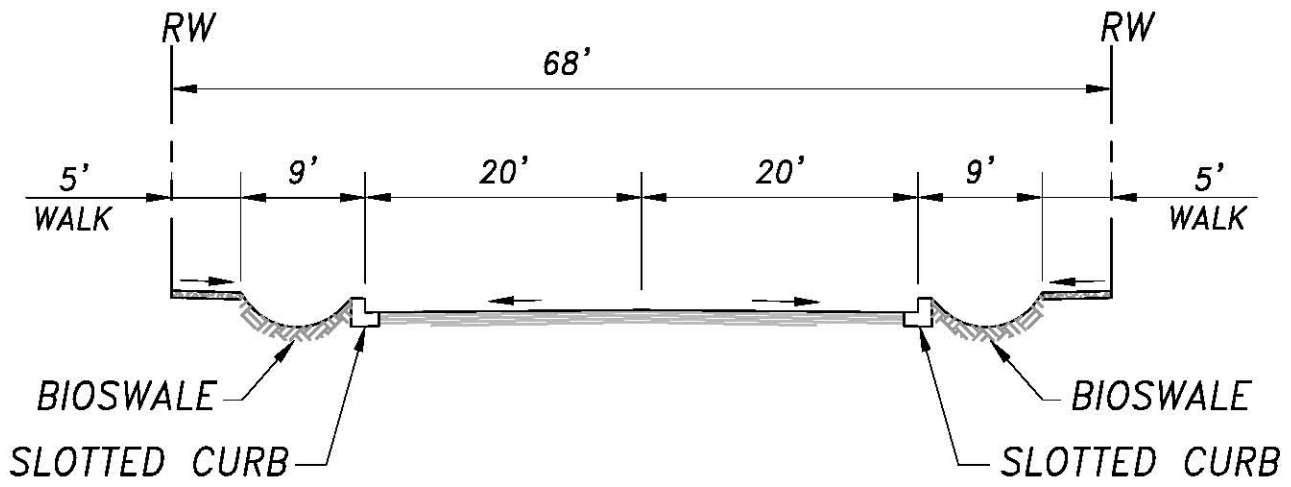

TYPICAL GREEN STREET W/ BIOSWALE SECTION

N.T.S.

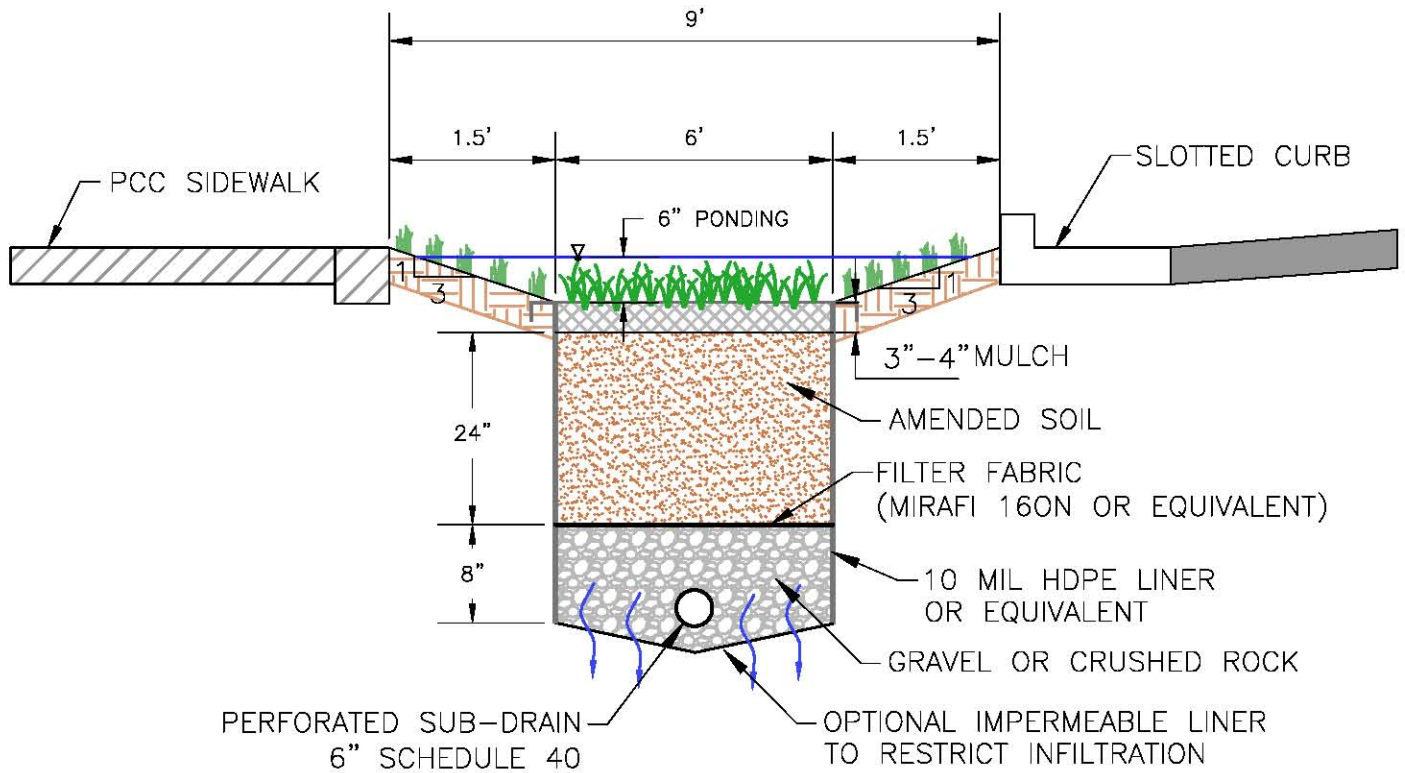

BIOCELL ENHANCEMENT CROSS SECTION

N.T.S.

**BIOCELL DETAILS
NEWPORT BANNING
RANCH**

Not-to-Scale
Exhibit Date: 2/3/2012

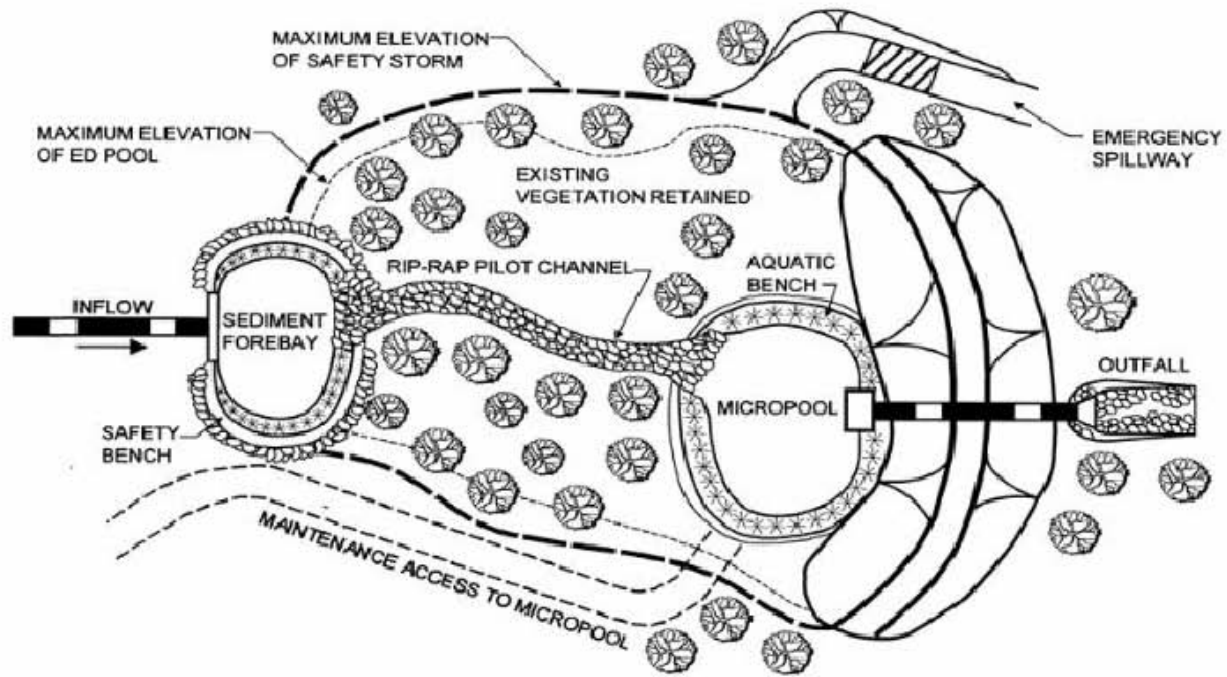

PLAN VIEW

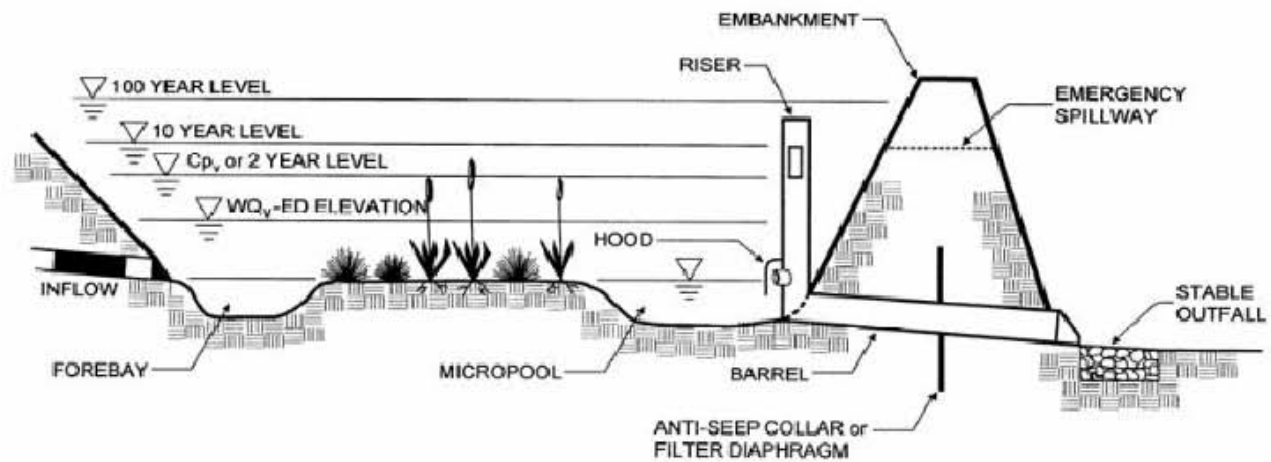

PROFILE

Schematic of an Extended Detention Basin (MDE, 2000)

**EXTENDED DETENTION
BASIN DETAILS
NEWPORT BANNING
RANCH**

Not-to-Scale
Exhibit Date: 2/3/2012

XIV.5. Biotreatment BMP Fact Sheets (BIO)

Conceptual criteria for biotreatment BMP selection, design, and maintenance are contained in [Appendix XII](#). These criteria are generally applicable to the design of biotreatment BMPs in Orange County and BMP-specific guidance is provided in the following fact sheets.

Note: Biotreatment BMPs shall be designed to provide the maximum feasible infiltration and ET based on criteria contained in [Appendix XI.2](#).

BIO-1: Bioretention with Underdrains

Bioretention stormwater treatment facilities are landscaped shallow depressions that capture and filter stormwater runoff. These facilities function as a soil and plant-based filtration device that removes pollutants through a variety of physical, biological, and chemical treatment processes. The facilities normally consist of a ponding area, mulch layer, planting soils, and plants. As stormwater passes down through the planting soil, pollutants are filtered, adsorbed, biodegraded, and sequestered by the soil and plants. Bioretention with an underdrain are utilized for areas with low permeability native soils or steep slopes where the underdrain system that routes the treated runoff to the storm drain system rather than depending entirely on infiltration.

[Bioretention must be designed without an underdrain](#) in areas of high soil permeability.

Also known as:

- Rain gardens with underdrains
- Vegetated media filter
- Downspout planter boxes



Bioretention
Source: Geosyntec Consultants

Feasibility Screening Considerations

- If there are no hazards associated with infiltration (such as groundwater concerns, contaminant plumes or geotechnical concerns), [bioinfiltration facilities](#), which achieve partial infiltration, should be used to maximize infiltration.
- Bioretention with underdrain facilities should be lined if contaminant plumes or geotechnical concerns exist. If high groundwater is the reason for infiltration infeasibility, bioretention facilities with underdrains do not need to be lined.

Opportunity Criteria

- Land use may include commercial, residential, mixed use, institutional, and subdivisions. Bioretention may also be applied in parking lot islands, cul-de-sacs, traffic circles, road shoulders, road medians, and next to buildings in planter boxes.
- Drainage area is ≤ 5 acres.
- Area is available for infiltration.

- Site must have adequate relief between land surface and the stormwater conveyance system to permit vertical percolation through the soil media and collection and conveyance in underdrain to stormwater conveyance system.

OC-Specific Design Criteria and Considerations

- Ponding depth should not exceed 18 inches; fencing may be required if ponding depth is greater than 6 inches to mitigate drowning.
- The minimum soil depth is 2 feet (3 feet is preferred).
- The maximum drawdown time of the bioretention ponding area is 48 hours. The maximum drawdown time of the planting media and gravel drainage layer is 96 hours, if applicable.
Infiltration pathways may need to be restricted due to the close proximity of roads, foundations, or other infrastructure. A geomembrane liner, or other equivalent water proofing, may be placed along the vertical walls to reduce lateral flows. This liner should have a minimum thickness of 30 mils.
- If infiltration in bioretention location is hazardous due to groundwater or geotechnical concerns, a geomembrane liner must be installed at the base of the bioretention facility. This liner should have a minimum thickness of 30 mils.
- The planting media placed in the cell shall be designed per the recommendations contained in MISC-1: Planting/Storage Media
- Plant materials should be tolerant of summer drought, ponding fluctuations, and saturated soil conditions for 48 hours; native place species and/or hardy cultivars that are not invasive and do not require chemical inputs should be used to the maximum extent feasible
- The bioretention area should be covered with 2-4 inches (average 3 inches) or mulch at the start and an additional placement of 1-2 inches of mulch should be added annually.
- Underdrain should be sized with a 6 inch minimum diameter and have a 0.5% minimum slope.
- Underdrain should be slotted polyvinyl chloride (PVC) pipe; underdrain pipe should be more than 5 feet from tree locations (if space allows).
- A gravel blanket or bedding is required for the underdrain pipe(s). At least 0.5 feet of washed aggregate must be placed below, to the top, and to the sides of the underdrain pipe(s).
- An overflow device is required at the top of the bioretention area ponding depth.
- Dispersed flow or energy dissipation (i.e. splash rocks) for piped inlets should be provided at basin inlet to prevent erosion.
- Ponding area side slopes shall be no steeper than 3:1 (H:V) unless designed as a planter box BMP with appropriate consideration for trip and fall hazards.

Simple Sizing Method for Bioretention with Underdrain

If the Simple Design Capture Volume Sizing Method described in **Appendix III.3.1** is used to size a bioretention with underdrain facility, the user selects the basin depth and then determines the appropriate surface area to capture the DCV. The sizing steps are as follows:

Step 1: Determine DCV

Calculate the DCV using the Simple Design Capture Volume Sizing Method described in **Appendix III.3.1**.

Step 2: Verify that the Ponding Depth will Draw Down within 48 Hours

The ponding area drawdown time can be calculated using the following equation:

$$DD_P = (d_P / K_{MEDIUM}) \times 12 \text{ in/ft}$$

Where:

DD_P = time to drain ponded water, hours

d_P = depth of ponding above bioretention area, ft (not to exceed 1.5 ft)

K_{MEDIUM} = media design infiltration rate, in/hr (equivalent to the media hydraulic conductivity with a factor of safety of 2; K_{MEDIUM} of 2.5 in/hr should be used unless other information is available)

If the drawdown time exceeds 48 hours, adjust ponding depth and/or media infiltration rate until 48 hour drawdown time is achieved.

Step 3: Determine the Depth of Water Filtered During Design Capture Storm

The depth of water filtered during the design capture storm can be estimated as the amount routed through the media during the storm, or the ponding depth, whichever is smaller.

$$d_{FILTERED} = \text{Minimum} [((K_{MEDIUM} \times T_{ROUTING})/12), d_P]$$

Where:

$d_{FILTERED}$ = depth of water that may be considered to be filtered during the design storm event, ft

K_{MEDIUM} = media design infiltration rate, in/hr (equivalent to the media hydraulic conductivity with a factor of safety of 2; K_{MEDIUM} of 2.5 in/hr should be used unless other information is available)

$T_{ROUTING}$ = storm duration that may be assumed for routing calculations; this should be assumed to be no greater than 3 hours. If the designer desires to account for further routing effects, the Capture Efficiency Method for Volume-Based, Constant Drawdown BMPs (See [Appendix III.3.2](#)) should be used.

d_P = depth of ponding above bioretention area, ft (not to exceed 1.5 ft)

Step 4: Determine the Facility Surface Area

$$A = DCV / (d_P + d_{FILTERED})$$

Where:

A = required area of bioretention facility, sq-ft

DCV = design capture volume, cu-ft

$d_{FILTERED}$ = depth of water that may be considered to be filtered during the design storm event, ft

d_P = depth of ponding above bioretention area, ft (not to exceed 1.5 ft)

Capture Efficiency Method for Bioretention with Underdrains

If the bioretention geometry has already been defined and the user wishes to account more explicitly for routing, the user can determine the required footprint area using the Capture Efficiency Method for Volume-Based, Constant Drawdown BMPs (See [Appendix III.3.2](#)) to determine the fraction of the DCV that must be provided to manage 80 percent of average annual runoff volume. This method accounts for drawdown time different than 48 hours.

Step 1: Determine the drawdown time associated with the selected basin geometry

$$DD = (d_P / K_{DESIGN}) \times 12 \text{ in/ft}$$

Where:

DD = time to completely drain infiltration basin ponding depth, hours

d_p = bioretention ponding depth, ft (should be less than or equal to 1.5 ft)

K_{DESIGN} = design media infiltration rate, in/hr (assume 2.5 inches per hour unless otherwise proposed)

If drawdown is less than 3 hours, the drawdown time should be rounded to 3 hours or the Capture Efficiency Method for Flow-based BMPs (See [Appendix III.3.3](#)) shall be used.

Step 2: Determine the Required Adjusted DCV for this Drawdown Time

Use the Capture Efficiency Method for Volume-Based, Constant Drawdown BMPs (See [Appendix III.3.2](#)) to calculate the fraction of the DCV the basin must hold to achieve 80 percent capture of average annual stormwater runoff volume based on the basin drawdown time calculated above.

Step 3: Determine the Basin Infiltrating Area Needed

The required infiltrating area (i.e. the surface area of the top of the media layer) can be calculated using the following equation:

$$A = \text{Design Volume} / d_p$$

Where:

A = required infiltrating area, sq-ft (measured at the media surface)

Design Volume = fraction of DCV, adjusted for drawdown, cu-ft (see Step 2)

d_p = ponding depth of water stored in bioretention area, ft (from Step 1)

This does not include the side slopes, access roads, etc. which would increase bioretention footprint. If the area required is greater than the selected basin area, adjust surface area or adjust ponding depth and recalculate required area until the required area is achieved.

Configuration for Use in a Treatment Train

- Bioretention areas may be preceded in a treatment train by HSCs in the drainage area, which would reduce the required design volume of the bioretention cell. For example, bioretention could be used to manage overflow from a cistern.
- Bioretention areas can be used to provide pretreatment for underground infiltration systems.

Additional References for Design Guidance

- CASQA BMP Handbook for New and Redevelopment:
<http://www.cabmphandbooks.com/Documents/Development/TC-32.pdf>
- SMC LID Manual (pp 68):
http://www.lowimpactdevelopment.org/guest75/pub/All_Projects/SoCal_LID_Manual/SoCalLID_Manual_FINAL_040910.pdf
- Los Angeles County Stormwater BMP Design and Maintenance Manual, Chapter 5:
http://dpw.lacounty.gov/DES/design_manuals/StormwaterBMPDesignandMaintenance.pdf
- San Diego County LID Handbook Appendix 4 (Factsheet 7):
<http://www.sdcounty.ca.gov/dplu/docs/LID-Appendices.pdf>
Los Angeles Unified School District (LAUSD) Stormwater Technical Manual, Chapter 4:
http://www.laschools.org/employee/design/fs-studies-and-reports/download/white_paper_report_material/Storm_Water_Technical_Manual_2009-opt-red.pdf?version_id=76975850
- County of Los Angeles Low Impact Development Standards Manual, Chapter 5:
http://dpw.lacounty.gov/wmd/LA_County_LID_Manual.pdf



Design Considerations

- Tributary Area
- Area Required
- Hydraulic Head

Description

Dry extended detention ponds (a.k.a. dry ponds, extended detention basins, detention ponds, extended detention ponds) are basins whose outlets have been designed to detain the stormwater runoff from a water quality design storm for some minimum time (e.g., 48 hours) to allow particles and associated pollutants to settle. Unlike wet ponds, these facilities do not have a large permanent pool. They can also be used to provide flood control by including additional flood detention storage.

California Experience

Caltrans constructed and monitored 5 extended detention basins in southern California with design drain times of 72 hours. Four of the basins were earthen, less costly and had substantially better load reduction because of infiltration that occurred, than the concrete basin. The Caltrans study reaffirmed the flexibility and performance of this conventional technology. The small headloss and few siting constraints suggest that these devices are one of the most applicable technologies for stormwater treatment.

Advantages

- Due to the simplicity of design, extended detention basins are relatively easy and inexpensive to construct and operate.
- Extended detention basins can provide substantial capture of sediment and the toxics fraction associated with particulates.
- Widespread application with sufficient capture volume can provide significant control of channel erosion and enlargement caused by changes to flow frequency

Targeted Constituents

<input checked="" type="checkbox"/>	Sediment	▲
<input checked="" type="checkbox"/>	Nutrients	●
<input checked="" type="checkbox"/>	Trash	■
<input checked="" type="checkbox"/>	Metals	▲
<input checked="" type="checkbox"/>	Bacteria	▲
<input checked="" type="checkbox"/>	Oil and Grease	▲
<input checked="" type="checkbox"/>	Organics	▲

Legend (*Removal Effectiveness*)

- Low
- High
- ▲ Medium



relationships resulting from the increase of impervious cover in a watershed.

Limitations

- Limitation of the diameter of the orifice may not allow use of extended detention in watersheds of less than 5 acres (would require an orifice with a diameter of less than 0.5 inches that would be prone to clogging).
- Dry extended detention ponds have only moderate pollutant removal when compared to some other structural stormwater practices, and they are relatively ineffective at removing soluble pollutants.
- Although wet ponds can increase property values, dry ponds can actually detract from the value of a home due to the adverse aesthetics of dry, bare areas and inlet and outlet structures.

Design and Sizing Guidelines

- Capture volume determined by local requirements or sized to treat 85% of the annual runoff volume.
- Outlet designed to discharge the capture volume over a period of hours.
- Length to width ratio of at least 1.5:1 where feasible.
- Basin depths optimally range from 2 to 5 feet.
- Include energy dissipation in the inlet design to reduce resuspension of accumulated sediment.
- A maintenance ramp and perimeter access should be included in the design to facilitate access to the basin for maintenance activities and for vector surveillance and control.
- Use a draw down time of 48 hours in most areas of California. Draw down times in excess of 48 hours may result in vector breeding, and should be used only after coordination with local vector control authorities. Draw down times of less than 48 hours should be limited to BMP drainage areas with coarse soils that readily settle and to watersheds where warming may be determined to downstream fisheries.

Construction/Inspection Considerations

- Inspect facility after first large to storm to determine whether the desired residence time has been achieved.
- When constructed with small tributary area, orifice sizing is critical and inspection should verify that flow through additional openings such as bolt holes does not occur.

Performance

One objective of stormwater management practices can be to reduce the flood hazard associated with large storm events by reducing the peak flow associated with these storms. Dry extended detention basins can easily be designed for flood control, and this is actually the primary purpose of most detention ponds.

Dry extended detention basins provide moderate pollutant removal, provided that the recommended design features are incorporated. Although they can be effective at removing some pollutants through settling, they are less effective at removing soluble pollutants because of the absence of a permanent pool. Several studies are available on the effectiveness of dry extended detention ponds including one recently concluded by Caltrans (2002).

The load reduction is greater than the concentration reduction because of the substantial infiltration that occurs. Although the infiltration of stormwater is clearly beneficial to surface receiving waters, there is the potential for groundwater contamination. Previous research on the effects of incidental infiltration on groundwater quality indicated that the risk of contamination is minimal.

There were substantial differences in the amount of infiltration that were observed in the earthen basins during the Caltrans study. On average, approximately 40 percent of the runoff entering the unlined basins infiltrated and was not discharged. The percentage ranged from a high of about 60 percent to a low of only about 8 percent for the different facilities. Climatic conditions and local water table elevation are likely the principal causes of this difference. The least infiltration occurred at a site located on the coast where humidity is higher and the basin invert is within a few meters of sea level. Conversely, the most infiltration occurred at a facility located well inland in Los Angeles County where the climate is much warmer and the humidity is less, resulting in lower soil moisture content in the basin floor at the beginning of storms.

Vegetated detention basins appear to have greater pollutant removal than concrete basins. In the Caltrans study, the concrete basin exported sediment and associated pollutants during a number of storms. Export was not as common in the earthen basins, where the vegetation appeared to help stabilize the retained sediment.

Siting Criteria

Dry extended detention ponds are among the most widely applicable stormwater management practices and are especially useful in retrofit situations where their low hydraulic head requirements allow them to be sited within the constraints of the existing storm drain system. In addition, many communities have detention basins designed for flood control. It is possible to modify these facilities to incorporate features that provide water quality treatment and/or channel protection. Although dry extended detention ponds can be applied rather broadly, designers need to ensure that they are feasible at the site in question. This section provides basic guidelines for siting dry extended detention ponds.

In general, dry extended detention ponds should be used on sites with a minimum area of 5 acres. With this size catchment area, the orifice size can be on the order of 0.5 inches. On smaller sites, it can be challenging to provide channel or water quality control because the orifice diameter at the outlet needed to control relatively small storms becomes very small and thus prone to clogging. In addition, it is generally more cost-effective to control larger drainage areas due to the economies of scale.

Extended detention basins can be used with almost all soils and geology, with minor design adjustments for regions of rapidly percolating soils such as sand. In these areas, extended detention ponds may need an impermeable liner to prevent ground water contamination.

The base of the extended detention facility should not intersect the water table. A permanently wet bottom may become a mosquito breeding ground. Research in Southwest Florida (Santana et al., 1994) demonstrated that intermittently flooded systems, such as dry extended detention ponds, produce more mosquitoes than other pond systems, particularly when the facilities remained wet for more than 3 days following heavy rainfall.

A study in Prince George's County, Maryland, found that stormwater management practices can increase stream temperatures (Galli, 1990). Overall, dry extended detention ponds increased temperature by about 5°F. In cold water streams, dry ponds should be designed to detain stormwater for a relatively short time (i.e., 24 hours) to minimize the amount of warming that occurs in the basin.

Additional Design Guidelines

In order to enhance the effectiveness of extended detention basins, the dimensions of the basin must be sized appropriately. Merely providing the required storage volume will not ensure maximum constituent removal. By effectively configuring the basin, the designer will create a long flow path, promote the establishment of low velocities, and avoid having stagnant areas of the basin. To promote settling and to attain an appealing environment, the design of the basin should consider the length to width ratio, cross-sectional areas, basin slopes and pond configuration, and aesthetics (Young et al., 1996).

Energy dissipation structures should be included for the basin inlet to prevent resuspension of accumulated sediment. The use of stilling basins for this purpose should be avoided because the standing water provides a breeding area for mosquitoes.

Extended detention facilities should be sized to completely capture the water quality volume. A micropool is often recommended for inclusion in the design and one is shown in the schematic diagram. These small permanent pools greatly increase the potential for mosquito breeding and complicate maintenance activities; consequently, they are not recommended for use in California.

A large aspect ratio may improve the performance of detention basins; consequently, the outlets should be placed to maximize the flowpath through the facility. The ratio of flowpath length to width from the inlet to the outlet should be at least 1.5:1 (L:W) where feasible. Basin depths optimally range from 2 to 5 feet.

The facility's drawdown time should be regulated by an orifice or weir. In general, the outflow structure should have a trash rack or other acceptable means of preventing clogging at the entrance to the outflow pipes. The outlet design implemented by Caltrans in the facilities constructed in San Diego County used an outlet riser with orifices



Figure 1
Example of Extended Detention Outlet Structure

sized to discharge the water quality volume, and the riser overflow height was set to the design storm elevation. A stainless steel screen was placed around the outlet riser to ensure that the orifices would not become clogged with debris. Sites either used a separate riser or broad crested weir for overflow of runoff for the 25 and greater year storms. A picture of a typical outlet is presented in Figure 1.

The outflow structure should be sized to allow for complete drawdown of the water quality volume in 72 hours. No more than 50% of the water quality volume should drain from the facility within the first 24 hours. The outflow structure can be fitted with a valve so that discharge from the basin can be halted in case of an accidental spill in the watershed.

Summary of Design Recommendations

- (1) **Facility Sizing** - The required water quality volume is determined by local regulations or the basin should be sized to capture and treat 85% of the annual runoff volume. See Section 5.5.1 of the handbook for a discussion of volume-based design.

Basin Configuration – A high aspect ratio may improve the performance of detention basins; consequently, the outlets should be placed to maximize the flowpath through the facility. The ratio of flowpath length to width from the inlet to the outlet should be at least 1.5:1 (L:W). The flowpath length is defined as the distance from the inlet to the outlet as measured at the surface. The width is defined as the mean width of the basin. Basin depths optimally range from 2 to 5 feet. The basin may include a sediment forebay to provide the opportunity for larger particles to settle out.

A micropool should not be incorporated in the design because of vector concerns. For online facilities, the principal and emergency spillways must be sized to provide 1.0 foot of freeboard during the 25-year event and to safely pass the flow from 100-year storm.

- (2) **Pond Side Slopes** - Side slopes of the pond should be 3:1 (H:V) or flatter for grass stabilized slopes. Slopes steeper than 3:1 (H:V) must be stabilized with an appropriate slope stabilization practice.
- (3) **Basin Lining** – Basins must be constructed to prevent possible contamination of groundwater below the facility.
- (4) **Basin Inlet** – Energy dissipation is required at the basin inlet to reduce resuspension of accumulated sediment and to reduce the tendency for short-circuiting.
- (5) **Outflow Structure** - The facility's drawdown time should be regulated by a gate valve or orifice plate. In general, the outflow structure should have a trash rack or other acceptable means of preventing clogging at the entrance to the outflow pipes.

The outflow structure should be sized to allow for complete drawdown of the water quality volume in 72 hours. No more than 50% of the water quality volume should drain from the facility within the first 24 hours. The outflow structure should be fitted with a valve so that discharge from the basin can be halted in case of an accidental spill in the watershed. This same valve also can be used to regulate the rate of discharge from the basin.

The discharge through a control orifice is calculated from:

$$Q = CA(2g(H-H_0))^{0.5}$$

where: Q = discharge (ft³/s)
 C = orifice coefficient
 A = area of the orifice (ft²)
 g = gravitational constant (32.2)
 H = water surface elevation (ft)
 H_0 = orifice elevation (ft)

Recommended values for C are 0.66 for thin materials and 0.80 when the material is thicker than the orifice diameter. This equation can be implemented in spreadsheet form with the pond stage/volume relationship to calculate drain time. To do this, use the initial height of the water above the orifice for the water quality volume. Calculate the discharge and assume that it remains constant for approximately 10 minutes. Based on that discharge, estimate the total discharge during that interval and the new elevation based on the stage volume relationship. Continue to iterate until H is approximately equal to H_0 . When using multiple orifices the discharge from each is summed.

- (6) Splitter Box - When the pond is designed as an offline facility, a splitter structure is used to isolate the water quality volume. The splitter box, or other flow diverting approach, should be designed to convey the 25-year storm event while providing at least 1.0 foot of freeboard along pond side slopes.
- (7) Erosion Protection at the Outfall - For online facilities, special consideration should be given to the facility's outfall location. Flared pipe end sections that discharge at or near the stream invert are preferred. The channel immediately below the pond outfall should be modified to conform to natural dimensions, and lined with large stone riprap placed over filter cloth. Energy dissipation may be required to reduce flow velocities from the primary spillway to non-erosive velocities.
- (8) Safety Considerations - Safety is provided either by fencing of the facility or by managing the contours of the pond to eliminate dropoffs and other hazards. Earthen side slopes should not exceed 3:1 (H:V) and should terminate on a flat safety bench area. Landscaping can be used to impede access to the facility. The primary spillway opening must not permit access by small children. Outfall pipes above 48 inches in diameter should be fenced.

Maintenance

Routine maintenance activity is often thought to consist mostly of sediment and trash and debris removal; however, these activities often constitute only a small fraction of the maintenance hours. During a recent study by Caltrans, 72 hours of maintenance was performed annually, but only a little over 7 hours was spent on sediment and trash removal. The largest recurring activity was vegetation management, routine mowing. The largest absolute number of hours was associated with vector control because of mosquito breeding that occurred in the stilling basins (example of standing water to be avoided) installed as energy dissipaters. In most cases, basic housekeeping practices such as removal of debris accumulations and vegetation

management to ensure that the basin dewater completely in 48-72 hours is sufficient to prevent creating mosquito and other vector habitats.

Consequently, maintenance costs should be estimated based primarily on the mowing frequency and the time required. Mowing should be done at least annually to avoid establishment of woody vegetation, but may need to be performed much more frequently if aesthetics are an important consideration.

Typical activities and frequencies include:

- Schedule semiannual inspection for the beginning and end of the wet season for standing water, slope stability, sediment accumulation, trash and debris, and presence of burrows.
- Remove accumulated trash and debris in the basin and around the riser pipe during the semiannual inspections. The frequency of this activity may be altered to meet specific site conditions.
- Trim vegetation at the beginning and end of the wet season and inspect monthly to prevent establishment of woody vegetation and for aesthetic and vector reasons.
- Remove accumulated sediment and re-grade about every 10 years or when the accumulated sediment volume exceeds 10 percent of the basin volume. Inspect the basin each year for accumulated sediment volume.

Cost

Construction Cost

The construction costs associated with extended detention basins vary considerably. One recent study evaluated the cost of all pond systems (Brown and Schueler, 1997). Adjusting for inflation, the cost of dry extended detention ponds can be estimated with the equation:

$$C = 12.4V^{0.760}$$

where: C = Construction, design, and permitting cost, and
V = Volume (ft³).

Using this equation, typical construction costs are:

\$ 41,600 for a 1 acre-foot pond

\$ 239,000 for a 10 acre-foot pond

\$ 1,380,000 for a 100 acre-foot pond

Interestingly, these costs are generally slightly higher than the predicted cost of wet ponds (according to Brown and Schueler, 1997) on a cost per total volume basis, which highlights the difficulty of developing reasonably accurate construction estimates. In addition, a typical facility constructed by Caltrans cost about \$160,000 with a capture volume of only 0.3 ac-ft.

An economic concern associated with dry ponds is that they might detract slightly from the value of adjacent properties. One study found that dry ponds can actually detract from the

perceived value of homes adjacent to a dry pond by between 3 and 10 percent (Emmerling-Dinovo, 1995).

Maintenance Cost

For ponds, the annual cost of routine maintenance is typically estimated at about 3 to 5 percent of the construction cost (EPA website). Alternatively, a community can estimate the cost of the maintenance activities outlined in the maintenance section. Table 1 presents the maintenance costs estimated by Caltrans based on their experience with five basins located in southern California. Again, it should be emphasized that the vast majority of hours are related to vegetation management (mowing).

Activity	Labor Hours	Equipment & Material (\$)	Cost
Inspections	4	7	183
Maintenance	49	126	2282
Vector Control	0	0	0
Administration	3	0	132
Materials	-	535	535
Total	56	\$668	\$3,132

References and Sources of Additional Information

Brown, W., and T. Schueler. 1997. *The Economics of Stormwater BMPs in the Mid-Atlantic Region*. Prepared for Chesapeake Research Consortium. Edgewater, MD. Center for Watershed Protection. Ellicott City, MD.

Denver Urban Drainage and Flood Control District. 1992. *Urban Storm Drainage Criteria Manual—Volume 3: Best Management Practices*. Denver, CO.

Emmerling-Dinovo, C. 1995. Stormwater Detention Basins and Residential Locational Decisions. *Water Resources Bulletin* 31(3): 515–521

Galli, J. 1990. *Thermal Impacts Associated with Urbanization and Stormwater Management Best Management Practices*. Metropolitan Washington Council of Governments. Prepared for Maryland Department of the Environment, Baltimore, MD.

GKY, 1989, *Outlet Hydraulics of Extended Detention Facilities* for the Northern Virginia Planning District Commission.

MacRae, C. 1996. Experience from Morphological Research on Canadian Streams: Is Control of the Two-Year Frequency Runoff Event the Best Basis for Stream Channel Protection? In *Effects of Watershed Development and Management on Aquatic Ecosystems*. American Society of Civil Engineers. Edited by L. Roesner. Snowbird, UT. pp. 144–162.

Maryland Dept of the Environment, 2000, Maryland Stormwater Design Manual: Volumes 1 & 2, prepared by MDE and Center for Watershed Protection.
<http://www.mde.state.md.us/environment/wma/stormwatermanual/index.html>

Metzger, M. E., D. F. Messer, C. L. Beitia, C. M. Myers, and V. L. Kramer. 2002. The Dark Side Of Stormwater Runoff Management: Disease Vectors Associated With Structural BMPs. *Stormwater* 3(2): 24-39.

Santana, F., J. Wood, R. Parsons, and S. Chamberlain. 1994. Control of Mosquito Breeding in Permitted Stormwater Systems. Prepared for Southwest Florida Water Management District, Brooksville, FL.

Schueler, T. 1997. Influence of Ground Water on Performance of Stormwater Ponds in Florida. *Watershed Protection Techniques* 2(4):525–528.

Watershed Management Institute (WMI). 1997. *Operation, Maintenance, and Management of Stormwater Management Systems*. Prepared for U.S. Environmental Protection Agency, Office of Water. Washington, DC.

Young, G.K., et al., 1996, *Evaluation and Management of Highway Runoff Water Quality*, Publication No. FHWA-PD-96-032, U.S. Department of Transportation, Federal Highway Administration, Office of Environment and Planning.

Information Resources

Center for Watershed Protection (CWP), Environmental Quality Resources, and Loiederman Associates. 1997. *Maryland Stormwater Design Manual*. Draft. Prepared for Maryland Department of the Environment, Baltimore, MD.

Center for Watershed Protection (CWP). 1997. *Stormwater BMP Design Supplement for Cold Climates*. Prepared for U.S. Environmental Protection Agency, Office of Wetlands, Oceans and Watersheds. Washington, DC.

U.S. Environmental Protection Agency (USEPA). 1993. *Guidance Specifying Management Measures for Sources of Nonpoint Pollution in Coastal Waters*. EPA-840-B-92-002. U.S. Environmental Protection Agency, Office of Water, Washington, DC.

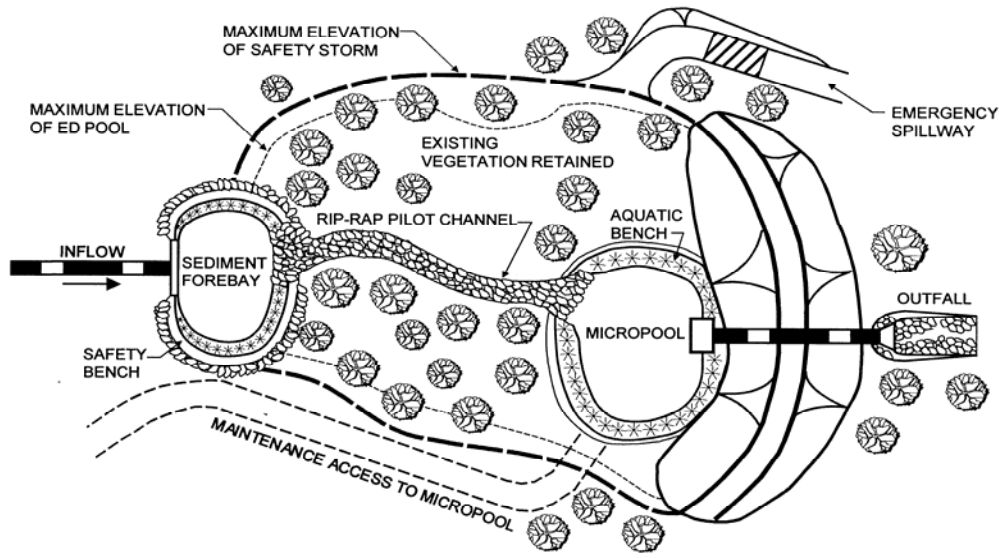

PLAN VIEW

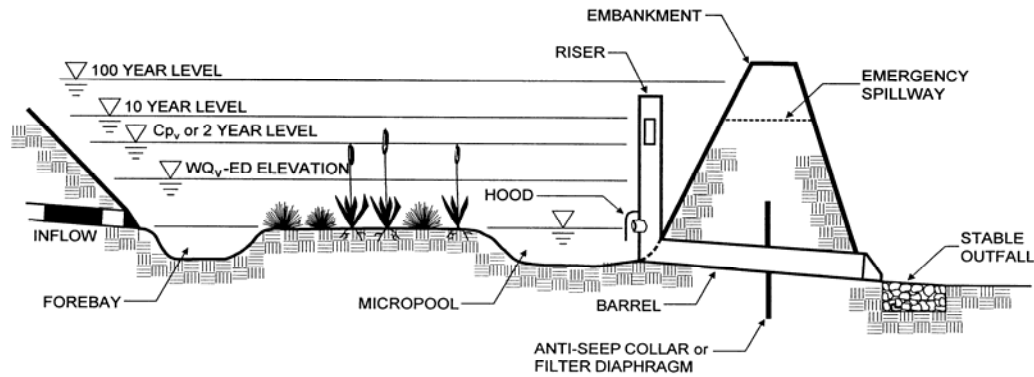

PROFILE

Schematic of an Extended Detention Basin (MDE, 2000)

SECTION VII EDUCATIONAL MATERIALS

The educational materials included in this WQMP are provided to inform people involved in future uses, activities, or ownership of the site about the potential pitfalls associated with careless storm water management. “The Ocean Begins at Your Front Door” provides users with information about storm water that is/will be generated on site, what happens when water enters a storm drain, and its ultimate fate, discharging into the ocean. Also included are activities guidelines to educate anyone who is or will be associated with activities that have a potential to impact storm water runoff quality, and provide a menu of BMPs to effectively reduce the generation of storm water runoff pollutants from a variety of activities. The educational materials that may be used for the proposed project are included in Appendix C of this WQMP and are listed below.

EDUCATION MATERIALS			
Residential Materials (http://www.ocwatersheds.com)	Check If Applicable	Business Materials (http://www.ocwatersheds.com)	Check If Applicable
The Ocean Begins at Your Front Door	<input checked="" type="checkbox"/>	Tips for the Automotive Industry	<input type="checkbox"/>
Tips for Car Wash Fund-raisers	<input type="checkbox"/>	Tips for Using Concrete and Mortar	<input type="checkbox"/>
Tips for the Home Mechanic	<input type="checkbox"/>	Tips for the Food Service Industry	<input checked="" type="checkbox"/>
Homeowners Guide for Sustainable Water Use	<input checked="" type="checkbox"/>	Proper Maintenance Practices for Your Business	<input checked="" type="checkbox"/>
Household Tips	<input checked="" type="checkbox"/>	Other Materials (http://www.ocwatersheds.com) (http://www.cabmphandbooks.com)	Check If Attached
Proper Disposal of Household Hazardous Waste	<input checked="" type="checkbox"/>		
Recycle at Your Local Used Oil Collection Center (North County)	<input type="checkbox"/>	DF-1 Drainage System Operation & Maintenance	<input checked="" type="checkbox"/>
Recycle at Your Local Used Oil Collection Center (Central County)	<input checked="" type="checkbox"/>	R-1 Automobile Repair & Maintenance	<input checked="" type="checkbox"/>
Recycle at Your Local Used Oil Collection Center (South County)	<input type="checkbox"/>	R-2 Automobile Washing	<input checked="" type="checkbox"/>
Tips for Maintaining Septic Tank Systems	<input type="checkbox"/>	R-3 Automobile Parking	<input checked="" type="checkbox"/>
Responsible Pest Control	<input checked="" type="checkbox"/>	R-4 Home & Garden Care Activities	<input checked="" type="checkbox"/>
Sewer Spill	<input type="checkbox"/>	R-5 Disposal of Pet Waste	<input checked="" type="checkbox"/>
Tips for the Home Improvement Projects	<input checked="" type="checkbox"/>	R-6 Disposal of Green Waste	<input checked="" type="checkbox"/>
Tips for Horse Care	<input type="checkbox"/>	R-7 Household Hazardous Waste	<input checked="" type="checkbox"/>
Tips for Landscaping and Gardening	<input checked="" type="checkbox"/>	R-8 Water Conservation	<input checked="" type="checkbox"/>
Tips for Pet Care	<input checked="" type="checkbox"/>	SD-10 Site Design & Landscape Planning	<input checked="" type="checkbox"/>
Tips for Pool Maintenance	<input checked="" type="checkbox"/>	SD-11 Roof Runoff Controls	<input checked="" type="checkbox"/>
Tips for Residential Pool, Landscape and Hardscape Drains	<input checked="" type="checkbox"/>	SD-12 Efficient Irrigation	<input checked="" type="checkbox"/>
Tips for Projects Using Paint	<input checked="" type="checkbox"/>	SD-13 Storm Drain Signage	<input checked="" type="checkbox"/>
Other:	<input type="checkbox"/>	SD-31 Maintenance Bays & Docs	<input type="checkbox"/>
Other:	<input type="checkbox"/>	SD-32 Trash Storage Areas	<input checked="" type="checkbox"/>

APPENDICES

Appendix A Supporting Calculations
Appendix B..... Notice of Transfer of Responsibility
Appendix C..... Educational Materials
Appendix D..... BMP Maintenance Supplement / O&M Plan
Appendix E..... Conditions of Approval (Placeholder – Pending Issuance)
Appendix F..... Memorandum on Limitations for Infiltration
Appendix G..... Planning-Level Water Quality Modeling

APPENDIX A

SUPPORTING CALCULATIONS

Water Quality LID Calculations - Newport Banning Ranch

Land Use Plan December 2009

For modeling purposes 12/22/2011

Drainage Area ID	Land Use Type	% impervious	Runoff Coefficient	Design Storm Depth (in)	Drainage Area (ac)	Impervious Area (ac)	Unit Conversion	Treatment Required DCV (ft ³)	Bioretention With Underdrains (Biotreatment)			Green Streets (Bioretention w/ Underdrains)			Length Required 6' Wide (total. ft)	Length Required (each side. ft)	Approx. Length Avail. (ft)
									Ponding Depth (ft)	Depth Filtered (ft)	Footprint Needed (ft ²)	Ponding Depth (ft)	Depth Filtered (ft)	Footprint Needed (ft ²)			
WCH Tributary - Storm Drain A																	
A19.4	Community Park	15%	0.26	0.7	3.90	0.59	3630	2,616	1.5	0.625	1,231.2	--	--	--	--	--	--
A19.2	Community Park	15%	0.26	0.7	6.81	1.02	3630	4,568	1.5	0.625	2,149.8	--	--	--	--	--	--
A7.3	Community Park	15%	0.26	0.7	4.18	0.63	3630	2,804	1.5	0.625	1,319.6	--	--	--	--	--	--
South Arroyo Tributary - Southerly Drainage Areas (Storm Drain B)																	
A12.1	Low Density Resid.	80%	0.75	0.7	2.97	2.38	3630	5,671	1.5	0.625	2,668.9	--	--	--	--	--	--
A12.10	Visitor Resort/Resid.	80%	0.75	0.7	4.62	3.70	3630	8,822	1.5	0.625	4,151.6	--	--	--	--	--	--
A12.11	Bluff Park	5%	0.19	0.7	0.41	0.02	3630	197	1.5	0.625	92.7	--	--	--	--	--	--
A12.12	Visitor Resort/Resid.	80%	0.75	0.7	5.47	4.38	3630	10,445	1.5	0.625	4,915.4	--	--	--	--	--	--
A12.13	Bluff Park	5%	0.19	0.7	1.80	0.09	3630	864	1.5	0.625	406.8	--	--	--	--	--	--
A12.14	Bluff Park	5%	0.19	0.7	1.26	0.06	3630	605	1.5	0.625	284.8	--	--	--	--	--	--
A12.15	Bluff Park	5%	0.19	0.7	1.03	0.05	3630	495	1.5	0.625	232.8	--	--	--	--	--	--
A12.2	Collector Road	90%	0.83	0.7	0.83	0.75	3630	1,743	1.5	0.625	820.3	--	--	--	--	--	--
A12.3	Medium Density Resid.	80%	0.75	0.7	2.67	2.14	3630	5,099	1.5	0.625	2,399.3	--	--	--	--	--	--
A12.4	Collector Road	90%	0.83	0.7	0.82	0.74	3630	1,722	1.5	0.625	810.4	--	--	--	--	--	--
A12.5	Low Density Resid.	80%	0.75	0.7	2.11	1.69	3630	4,029	1.5	0.625	1,896.1	--	--	--	--	--	--
A12.6	Collector Road	90%	0.83	0.7	0.90	0.81	3630	1,890	1.5	0.625	889.5	--	--	--	--	--	--
A12.7	Low Density Resid.	80%	0.75	0.7	2.19	1.75	3630	4,182	1.5	0.625	1,968.0	--	--	--	--	--	--
A12.8	Medium Density Resid.	80%	0.75	0.7	3.98	3.18	3630	7,600	1.5	0.625	3,576.5	--	--	--	--	--	--
A12.9	Collector Road	90%	0.83	0.7	1.17	1.05	3630	2,457	--	--	--	0.50	0.50	2,457.2	--	--	--
A20.4	Bluff Park	5%	0.19	0.7	1.24	0.06	3630	596	1.5	0.625	280.2	--	--	--	--	--	--
TOTAL	--	68.25%	0.66	0.7	33.47	22.84	3630	56,418	1.5	0.625	26,549.5	--	--	--	--	--	--
South Arroyo Tributary - Northerly Drainage Areas (Storm Drain C)																	
A11.4	Medium Density Resid.	80%	0.75	0.7	3.27	2.62	3630	6,244	1.5	0.625	2,938.5	--	--	--	--	--	--
A11.1	Arterial Road	90%	0.83	0.7	0.57	0.51	3630	1,197	--	--	--	0.50	0.50	1,197.1	--	--	--
A11.10	Low-Medium Resid.	80%	0.75	0.7	0.93	0.74	3630	1,776	1.5	0.625	835.7	--	--	--	--	--	--
A11.11	Bluff Park	15%	0.26	0.7	0.85	0.13	3630	570	1.5	0.625	268.3	--	--	--	--	--	--
A11.12	Collector Road	90%	0.83	0.7	0.50	0.45	3630	1,050	1.5	0.625	494.1	--	--	--	--	--	--
A11.13	Bluff Park	15%	0.26	0.7	0.85	0.13	3630	570	1.5	0.625	268.3	--	--	--	--	--	--
A11.14	Low-Medium Resid.	80%	0.75	0.7	1.04	0.83	3630	1,986	1.5	0.625	934.6	--	--	--	--	--	--
A11.15	Collector Road	90%	0.83	0.7	1.47	1.32	3630	3,087	1.5	0.625	1,452.8	--	--	--	--	--	--
A11.16	Bluff Park	15%	0.26	0.7	0.83	0.12	3630	557	1.5	0.625	262.0	--	--	--	--	--	--
A11.17	Low Density Resid.	60%	0.60	0.7	4.84	2.90	3630	7,398	1.5	0.625	3,481.2	--	--	--	--	--	--
A11.3	Collector Road	90%	0.83	0.7	0.65	0.59	3630	1,365	1.5	0.625	642.4	--	--	--	--	--	--
A11.5	Collector Road	90%	0.83	0.7	0.61	0.55	3630	1,281	1.5	0.625	602.9	--	--	--	--	--	--
A11.6	Bluff Park	15%	0.26	0.7	1.02	0.15	3630	684	1.5	0.625	322.0	--	--	--	--	--	--
A11.7	Collector Road	90%	0.83	0.7	0.68	0.61	3630	1,428	1.5	0.625	672.0	--	--	--	--	--	--
A11.8	Medium Density Resid.	80%	0.75	0.7	3.06	2.45	3630	5,843	1.5	0.625	2,749.8	--	--	--	--	--	--
A11.9	Collector Road	90%	0.83	0.7	0.83	0.75	3630	1,743	--	--	--	0.50	0.50	1,743.1	--	--	--
A8.2	Bluff Park	15%	0.26	0.7	0.94	0.14	3630	631	1.5	0.625	296.7	--	--	--	--	--	--
TOTAL	--	65.37%	0.64	0.7	22.94	15.00	3630	37,411	1.5	0.625	17,605.0	--	--	--	--	--	--

Drainage Area ID	Land Use Type	% impervious	Runoff Coefficient	Design Storm Depth (in)	Drainage Area (ac)	Impervious Area (ac)	Unit Conversion	Treatment Required DCV (ft³)	Bioretention With Underdrains (Biotreatment)			Green Streets (Bioretention w/ Underdrains)			Length Required 6' Wide (total. ft)	Length Required (each side. ft)	Approx. Length Avail. (ft)
									Ponding Depth (ft)	Depth Filtered (ft)	Footprint Needed (ft²)	Ponding Depth (ft)	Depth Filtered (ft)	Footprint Needed (ft²)			
Lowlands Tributary - West of Bluff Rd. (Storm Drain D)																	
C10	Off-site Contribution	90%	0.83	0.7	0.88	0.79	3630	1,848	1.5	0.625	869.7	--	--	--	--	--	--
C11	Off-site Contribution	90%	0.83	0.7	1.06	0.95	3630	2,226	1.5	0.625	1,047.6	--	--	--	--	--	--
C12.1	Arterial Road	90%	0.83	0.7	1.10	0.99	3630	2,310	--	--	--	0.50	0.50	2,310.2	--	--	--
C13.1	Collector Road	90%	0.83	0.7	0.55	0.50	3630	1,155	1.5	0.625	543.6	--	--	--	--	--	--
C13.2	Open Space/Trails	15%	0.26	0.7	3.72	0.56	3630	2,495	1.5	0.625	1,174.3	--	--	--	--	--	--
C14	Collector Road	90%	0.83	0.7	0.83	0.75	3630	1,743	1.5	0.625	820.3	--	--	--	--	--	--
C15	Interpretive Parks	0%	0.15	0.7	4.82	0.00	3630	1,856	1.5	0.625	873.2	--	--	--	--	--	--
C3.1	Arterial Road	90%	0.83	0.7	2.39	2.15	3630	5,019	--	--	--	0.50	0.50	5,019.3	--	--	--
C3.2	Medium Density Resid.	80%	0.75	0.7	2.66	2.13	3630	5,079	1.5	0.625	2,390.3	--	--	--	--	--	--
C3.3	Collector Road	90%	0.83	0.7	0.68	0.61	3630	1,428	1.5	0.625	672.0	--	--	--	--	--	--
C4.1	Mixed Use/Residential	80%	0.75	0.7	8.42	6.74	3630	16,079	1.5	0.625	7,566.4	--	--	--	--	--	--
C4.2	Arterial Road	90%	0.83	0.7	1.72	1.55	3630	3,612	--	--	--	0.50	0.50	3,612.2	--	--	--
C4.3	Collector Road	90%	0.83	0.7	0.60	0.54	3630	1,260	1.5	0.625	593.0	--	--	--	--	--	--
C4.4	Low-Medium Resid.	80%	0.75	0.7	1.13	0.90	3630	2,158	1.5	0.625	1,015.4	--	--	--	--	--	--
C4.5	Collector Road	90%	0.83	0.7	0.53	0.48	3630	1,113	--	--	--	0.50	0.50	1,113.1	--	--	--
C5.1	Medium Density Resid.	80%	0.75	0.7	3.20	2.56	3630	6,111	1.5	0.625	2,875.6	--	--	--	--	--	--
C5.2	Collector Road	90%	0.83	0.7	0.98	0.88	3630	2,058	--	--	--	0.50	0.50	2,058.1	--	--	--
C5.3	Low-Medium Resid.	80%	0.75	0.7	1.39	1.11	3630	2,654	1.5	0.625	1,249.1	--	--	--	--	--	--
C6.1	Collector Road	90%	0.83	0.7	0.37	0.33	3630	777	1.5	0.625	365.7	--	--	--	--	--	--
C6.2	Collector Road	90%	0.83	0.7	1.06	0.95	3630	2,226	1.5	0.625	1,047.6	--	--	--	--	--	--
C6.3	Low-Medium Resid.	80%	0.75	0.7	1.47	1.18	3630	2,807	1.5	0.625	1,321.0	--	--	--	--	--	--
C6.4	Low-Medium Resid.	80%	0.75	0.7	2.24	1.79	3630	4,277	1.5	0.625	2,012.9	--	--	--	--	--	--
C6.5	Collector Road	90%	0.83	0.7	0.28	0.25	3630	588	1.5	0.625	276.7	--	--	--	--	--	--
C7.1	Low Density Resid.	60%	0.60	0.7	3.96	2.38	3630	6,053	1.5	0.625	2,848.2	--	--	--	--	--	--
C7.2	Collector Road	90%	0.83	0.7	1.26	1.13	3630	2,646	--	--	--	0.50	0.50	2,646.2	--	--	--
C7.3	Bluff Park	15%	0.26	0.7	0.76	0.11	3630	510	1.5	0.625	239.9	--	--	--	--	--	--
C8.1	Collector Road	90%	0.83	0.7	1.68	1.51	3630	3,528	1.5	0.625	1,660.3	--	--	--	--	--	--
C8.2	Low Density Resid.	60%	0.60	0.7	4.58	2.75	3630	7,000	1.5	0.625	3,294.2	--	--	--	--	--	--
C9	Bluff Park	15%	0.26	0.7	1.11	0.17	3630	745	1.5	0.625	350.4	--	--	--	--	--	--
TOTAL	--	66.29%	0.65	0.7	55.43	36.74	3630	91,362	1.5	0.625	42,994.0	--	--	--	--	--	--
Lowlands Tributary - East of Bluff Rd. (Storm Drain E)																	
C12.2	Mixed Use/Residential	80%	0.75	0.7	5.11	4.09	3630	9,758	1.5	0.625	4,591.9	--	--	--	--	--	--
Lowlands Tributary - Storm Drain F																	
B11.1	Mixed Use/Residential	80%	0.75	0.7	4.57	3.66	3630	8,727	1.5	0.625	4,106.7	--	--	--	--	--	--

Drainage Area ID	Land Use Type	% impervious	Runoff Coefficient	Design Storm Depth (in)	Drainage Area (ac)	Impervious Area (ac)	Unit Conversion	Treatment Required DCV (ft ³)	Bioretention With Underdrains (Biotreatment)			Green Streets (Bioretention w/ Underdrains)			Length Required 6' Wide (total. ft)	Length Required (each side. ft)	Approx. Length Avail. (ft)
									Ponding Depth (ft)	Depth Filtered (ft)	Footprint Needed (ft ²)	Ponding Depth (ft)	Depth Filtered (ft)	Footprint Needed (ft ²)			
Green Streets - Total (includes areas above)																	
A11.1	Arterial Road	90%	0.83	0.7	0.57	0.51	3630	1,197	--	--	--	0.50	0.50	1,197.1	199.5	99.8	274.0
A11.9	Arterial Road	90%	0.83	0.7	0.83	0.75	3630	1,743	--	--	--	0.50	0.50	1,743.1	290.5	145.3	470.0
A19.1	Arterial Road	90%	0.83	0.7	1.09	0.98	3630	2,289	--	--	--	0.50	0.50	2,289.1	381.5	190.8	420.0
A19.3	Arterial Road	90%	0.83	0.7	1.58	1.42	3630	3,318	--	--	--	0.50	0.50	3,318.2	553.0	276.5	550.0
A19.5	Arterial Road	90%	0.83	0.7	2.93	2.64	3630	6,153	--	--	--	0.50	0.50	6,153.4	1,025.6	512.8	795.0
A19.7	Arterial Road	90%	0.83	0.7	2.52	2.27	3630	5,292	--	--	--	0.50	0.50	5,292.3	882.1	441.0	822.0
A7.5	Arterial Road	90%	0.83	0.7	1.9	1.71	3630	3,990	--	--	--	0.50	0.50	3,990.3	665.0	332.5	700.0
C5.2	Arterial Road	90%	0.83	0.7	0.98	0.88	3630	2,058	--	--	--	0.50	0.50	2,058.1	343.0	171.5	475.0
C4.5	Arterial Road	90%	0.83	0.7	0.53	0.48	3630	1,113	--	--	--	0.50	0.50	1,113.1	185.5	92.8	274.0
C3.1	Arterial Road	90%	0.83	0.7	3.39	3.05	3630	7,119	--	--	--	0.50	0.50	7,119.5	1,186.6	593.3	859.0
C4.2	Arterial Road	90%	0.83	0.7	1.72	1.55	3630	3,612	--	--	--	0.50	0.50	3,612.2	602.0	301.0	460.0
C7.2	Arterial Road	90%	0.83	0.7	0.63	0.57	3630	1,323	--	--	--	0.50	0.50	1,323.1	220.5	110.3	350.0
C12.1	Arterial Road	90%	0.83	0.7	1.1	0.99	3630	2,310	--	--	--	0.50	0.50	2,310.2	385.0	192.5	440.0
B11.3	Arterial Road	90%	0.83	0.7	2.21	1.99	3630	4,641	--	--	--	0.50	0.50	4,641.3	773.6	386.8	1,310.0
D3.2	Arterial Road	90%	0.83	0.7	2.72	2.45	3630	5,712	--	--	--	0.50	0.50	5,712.4	952.1	476.0	1,470.0
A12.9	Collector Road	90%	0.83	0.7	1.17	1.05	3630	2,457	--	--	--	0.50	0.50	2,457.2	409.5	204.8	647.0

SUBJECT TO FURTHER REVISION

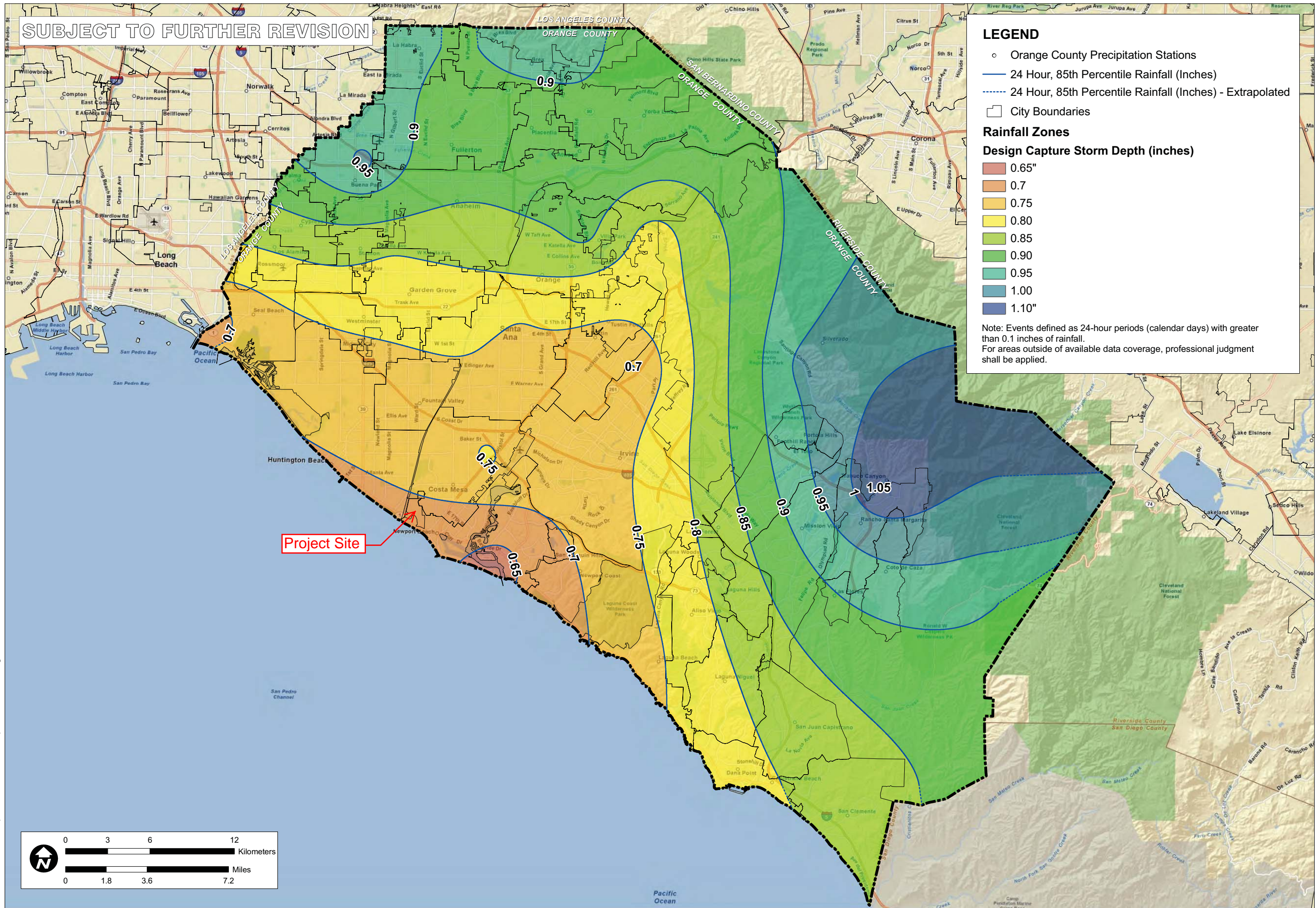

LEGEND

- Orange County Precipitation Stations
- 24 Hour, 85th Percentile Rainfall (Inches)
- - - 24 Hour, 85th Percentile Rainfall (Inches) - Extrapolated
- City Boundaries

Rainfall Zones

Design Capture Storm Depth (inches)

- 0.65"
- 0.7
- 0.75
- 0.80
- 0.85
- 0.90
- 0.95
- 1.00
- 1.10"

Note: Events defined as 24-hour periods (calendar days) with greater than 0.1 inches of rainfall.
For areas outside of available data coverage, professional judgment shall be applied.

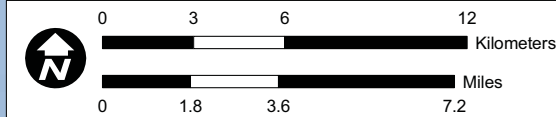

RAINFALL ZONES

ORANGE COUNTY
TECHNICAL GUIDANCE
DOCUMENT

SCALE	1" = 1.8 miles
DESIGNED	TH
DRAWING	TH
CHECKED	BMP
DATE	04/22/10
JOB NO.	9526-E



FIGURE
XVI-1

P:\9526E\6-GIS\Mxds\Reports\Infiltration\Fecsoability_20110215\9526E_FigureXVI-1_RainfallZones_20110215.mxd

SUBJECT TO FURTHER REVISION

LEGEND

□ City Boundaries

Hydrologic Soil Groups

■ D Soils

Source:
 D Soils: Natural Resources Conservation Service (NRCS)
 Soil Survey - soil_ca678, Orange County & Western Riverside
 Date of publication: 2006-02-08
<http://websoilsurvey.nrcs.usda.gov/app/HomePage.htm>

Project Site

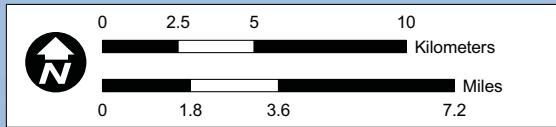

TITLE
 HYDROLOGIC SOIL GROUP
 TYPE D NRCS SOIL SURVEY

JOB
 ORANGE COUNTY
 INFILTRATION STUDY

SCALE	1" = 1.8 miles
DESIGNED	TH
DRAWING	TH
CHECKED	BMP
DATE	02/09/11
JOB NO.	9526-E

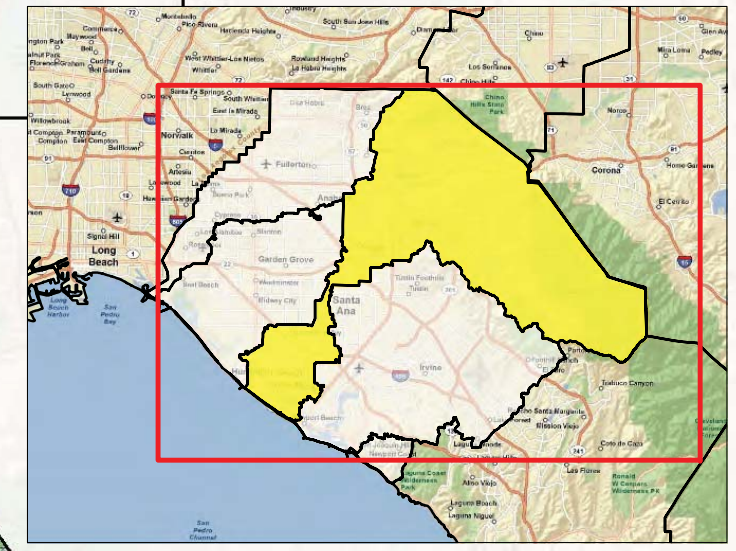
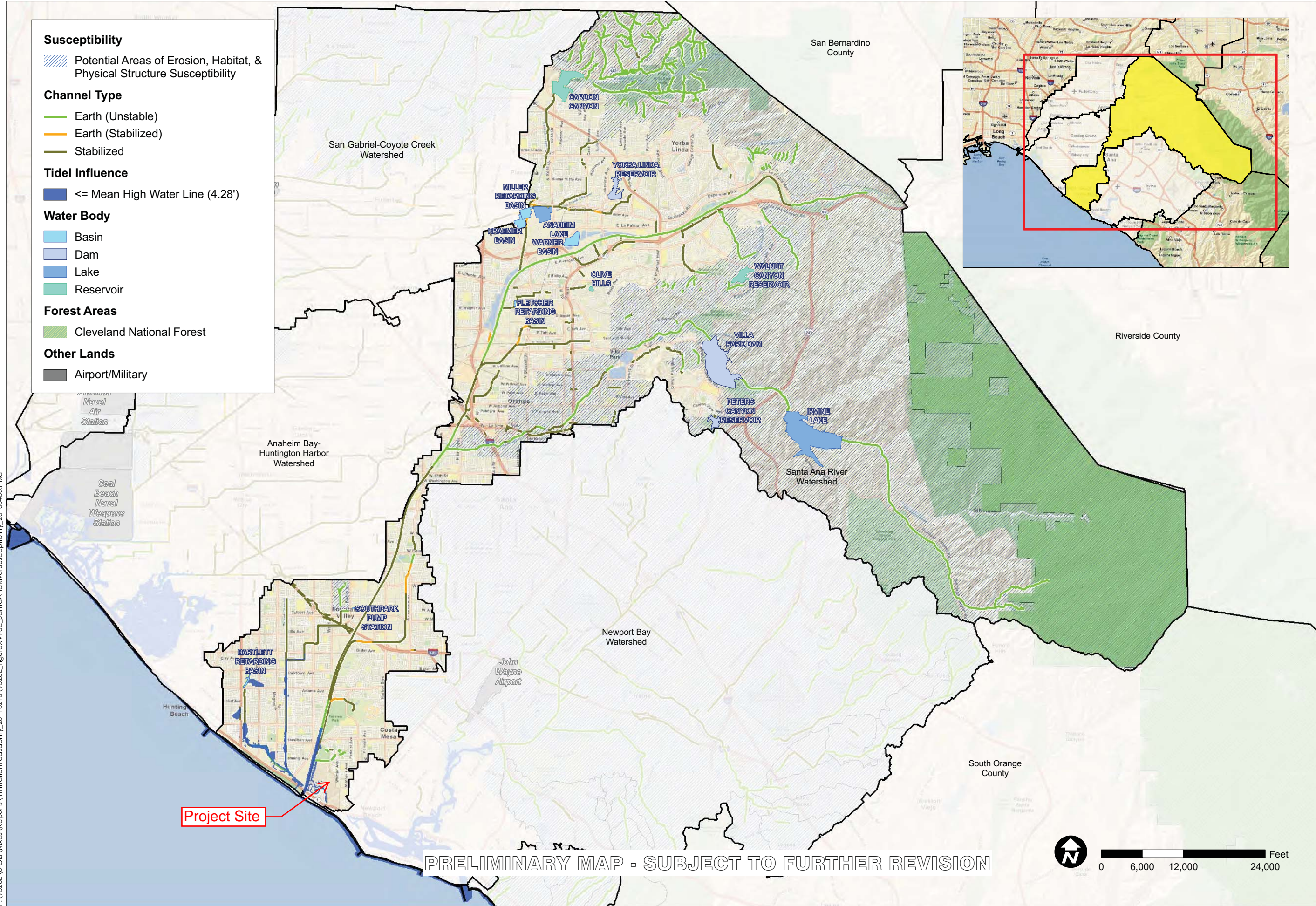

FIGURE
 XVI-2b

P:\9526E\6-GIS\Mxds\Reports\Infiltration\Feasibility_20110215\9526E_FigureXVI-2b_D-Soils_20110215.mxd

P:\9526E\6-GIS\Reports\Infiltration\Feasibility_20110215\9526E_FigureXVI-3c_SantaAnaRiverSusceptibility_20100430.mxd

- Susceptibility**
- Potential Areas of Erosion, Habitat, & Physical Structure Susceptibility
- Channel Type**
- Earth (Unstable)
 - Earth (Stabilized)
 - Stabilized
- Tidel Influence**
- <= Mean High Water Line (4.28')
- Water Body**
- Basin
 - Dam
 - Lake
 - Reservoir
- Forest Areas**
- Cleveland National Forest
- Other Lands**
- Airport/Military



Project Site

PRELIMINARY MAP - SUBJECT TO FURTHER REVISION

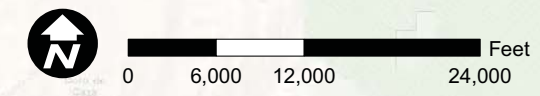

TITLE

**SUSCEPTIBILITY ANALYSIS
SANTA ANA RIVER**

ORANGE COUNTY
WATERSHED
MASTER PLANNING

JOB

SCALE 1" = 6000'

DESIGNED	TH
DRAWING	TH
CHECKED	EMP
DATE	04/30/10
JOB NO.	9526-E

ORANGE CO. CA

FIGURE

XVI-3c

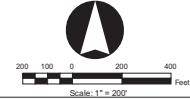
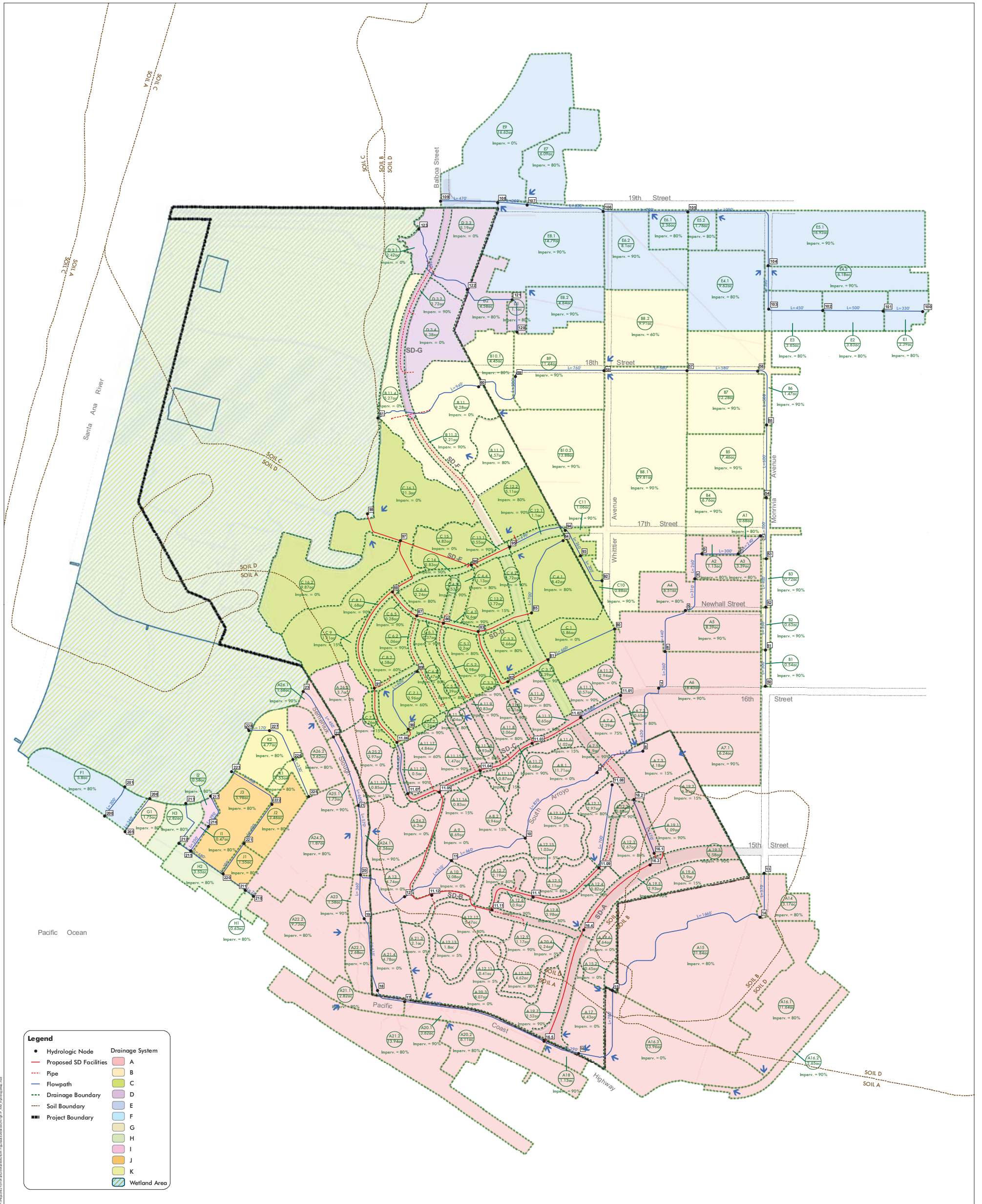

APPENDIX B

NOTICE OF TRANSFER OF RESPONSIBILITY

NOTICE OF TRANSFER OF RESPONSIBILITY

WATER QUALITY MANAGEMENT PLAN

Newport Banning Ranch
Tentative Tract Map 17308

Submission of this Notice Of Transfer of Responsibility constitutes notice to the City of Newport Beach that responsibility for the Water Quality Management Plan ("WQMP") for the subject property identified below, and implementation of that plan, is being transferred from the Previous Owner (and his/her agent) of the site (or a portion thereof) to the New Owner, as further described below.

I. Previous Owner/ Previous Responsible Party Information

Company/ Individual Name:		Contact Person:	
Street Address:		Title:	
City:	State:	ZIP:	Phone:

II. Information about Site Transferred

Name of Project (if applicable):	
Title of WQMP Applicable to site:	
Street Address of Site (if applicable):	
Planning Area (PA) and/ or Tract Number(s) for Site:	Lot Numbers (if Site is a portion of a tract):
Date WQMP Prepared (and revised if applicable):	

III. New Owner/ New Responsible Party Information

Company/ Individual Name:		Contact Person:	
Street Address:		Title:	
City:	State:	ZIP:	Phone:

IV. Ownership Transfer Information

General Description of Site Transferred to New Owner:	General Description of Portion of Project/ Parcel Subject to WQMP Retained by Owner (if any):
---	---

Lot/ Tract Numbers of Site Transferred to New Owner:
Remaining Lot/ Tract Numbers Subject to WQMP Still Held by Owner (if any):
Date of Ownership Transfer:

Note: When the Previous Owner is transferring a Site that is a portion of a larger project/ parcel addressed by the WQMP, as opposed to the entire project/parcel addressed by the WQMP, the General Description of the Site transferred and the remainder of the project/ parcel no transferred shall be set forth as maps attached to this notice. These maps shall show those portions of a project/ parcel addressed by the WQMP that are transferred to the New Owner (the Transferred Site), those portions retained by the Previous Owner, and those portions previously transferred by Previous Owner. Those portions retained by Previous Owner shall be labeled as "Previously Transferred".

V. Purpose of Notice of Transfer

The purposes of this Notice of Transfer of Responsibility are: 1) to track transfer of responsibility for implementation and amendment of the WQMP when property to which the WQMP is transferred from the Previous Owner to the New Owner, and 2) to facilitate notification to a transferee of property subject to a WQMP that such New Order is now the Responsible Party of record for the WQMP for those portions of the site that it owns.

VI. Certifications

A. Previous Owner

I certify under penalty of law that I am no longer the owner of the Transferred Site as described in Section II above. I have provided the New Owner with a copy of the WQMP applicable to the Transferred Site that the New Owner is acquiring from the Previous Owner.

Printed Name of Previous Owner Representative:	Title:
Signature of Previous Owner Representative:	Date:

B. New Owner

I certify under penalty of law that I am the owner of the Transferred Site, as described in Section II above, that I have been provided a copy of the WQMP, and that I have informed myself and understand the New Owner's responsibilities related to the WQMP, its implementation, and Best Management Practices associated with it. I understand that by signing this notice, the New Owner is accepting all ongoing responsibilities for implementation and amendment of the WQMP for the Transferred Site, which the New Owner has acquired from the Previous Owner.

Printed Name of New Owner Representative:	Title:
Signature:	Date: